



KX5

CONTROLLER, PROGRAMMER and SET POINT SETTER



Engineering Manual

Code : ISTR-MKX5ENG00 - Vr. 0.0 (ENG)

ASCON TECHNOLOGIC S.r.l.

Viale Indipendenza, 56 - 27029 VIGEVANO (PV) ITALY

Tel.: +39 0381 69871 - Fax: +39 0381 698730

Site: <http://www.ascontecnologic.com>

e-mail: info@ascontecnologic.com

1 OUTLINE DIMENSIONS (mm)

1.1 Dimensions

Instrument with non-removable terminals

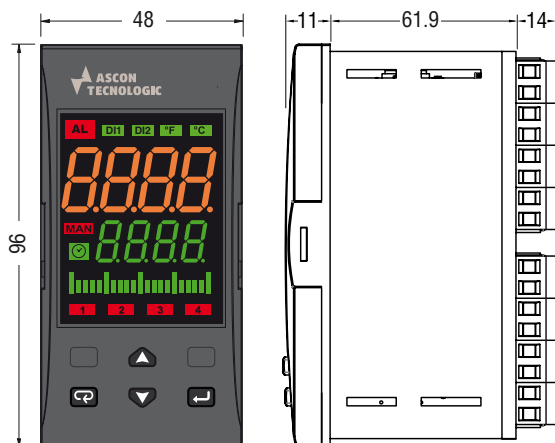

Removable terminals

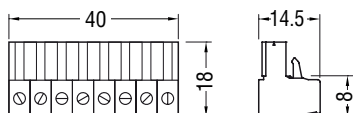

1.2 Panel cutout

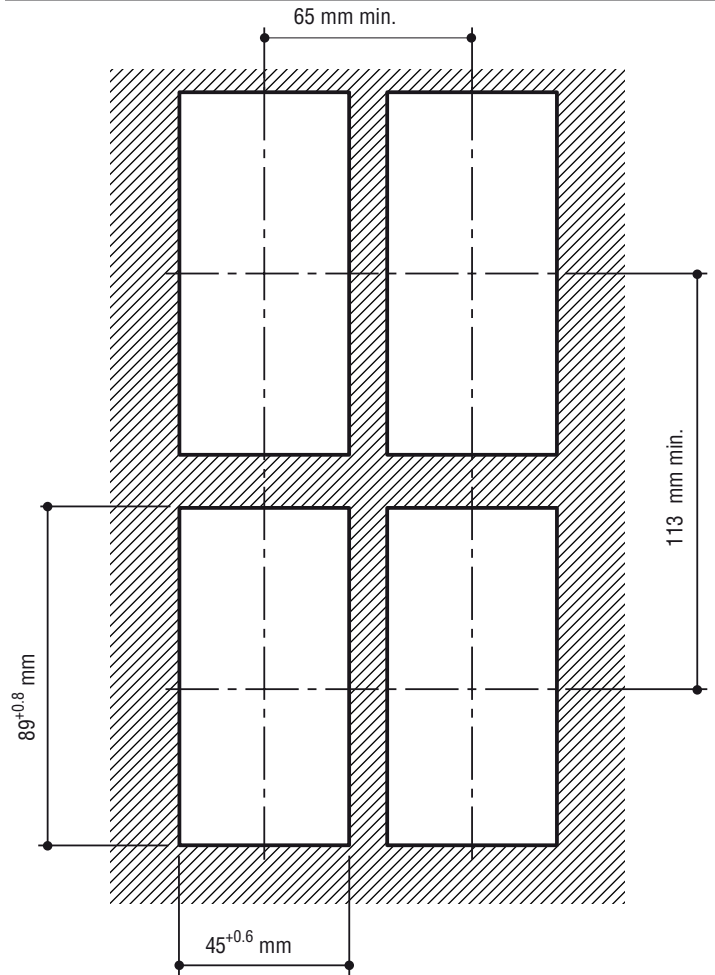

1.3 Mounting requirements

This instrument is intended for permanent installation, for indoor use only, in an electrical panel which encloses the rear housing, exposed terminals and wiring on the back.

Select a mounting location having the following characteristics:

1. It should be easily accessible;
2. There is minimum vibrations and no impact;
3. There are no corrosive gases;
4. There are no water or other fluids (i.e. condensation);
5. The ambient temperature is in accordance with the operative temperature (0... 50°C);
6. The relative humidity is in accordance with the instrument specifications (20... 85%);

The instrument can be mounted on panel with a maximum thickness of 15 mm.

When the maximum front protection (IP65) is desired, the optional gasket must be monted.

2.1 Wiring diagram

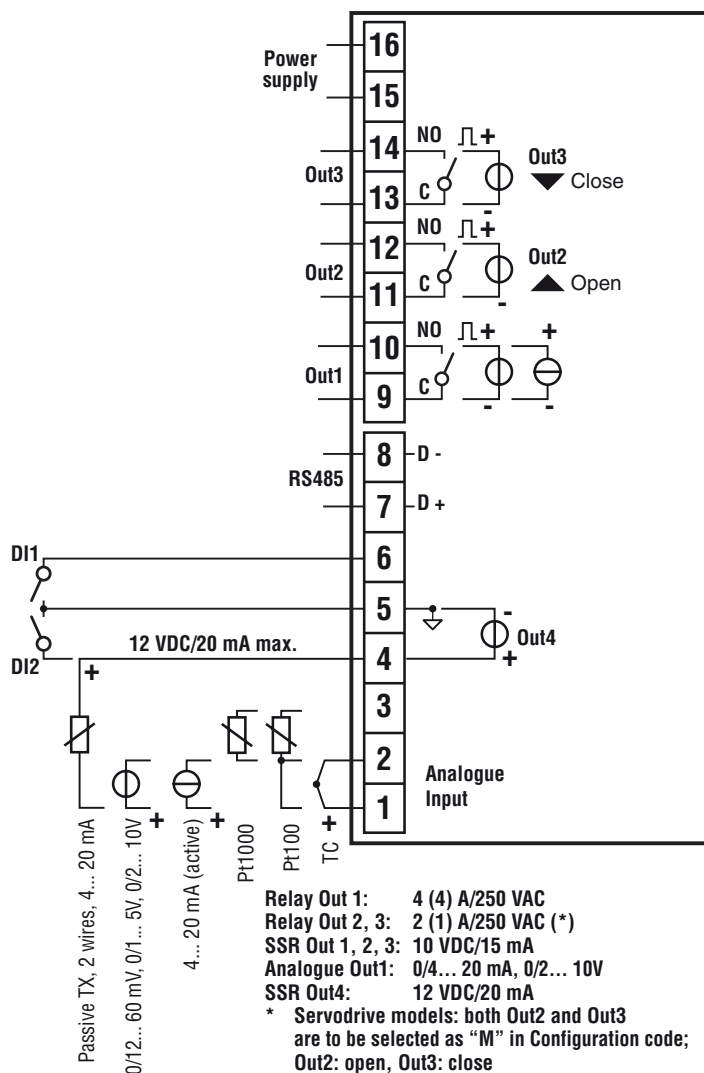

2.2 General notes about wiring

1. Do not run input wires together with power cables.
2. External components (like zener barriers, etc.) connected between sensor and input terminals may cause errors in measurement due to excessive and/or not balanced line resistance or possible leakage currents.
3. When a shielded cable is used, it should be connected at one point only.
4. Pay attention to the line resistance; a high line resistance may cause measurement errors.

2.3 Inputs

2.3.1 Thermocouple Input

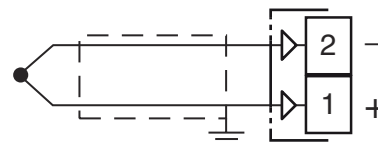

- External resistance:** 100Ω max., maximum error 25 μV.
- Cold junction:** automatic compensation between 0... 50°C.
- Cold junction accuracy:** 0.1°C/°C after a warm-up of 20 minutes.
- Input impedance:** > 1 MΩ.
- Calibration:** According to EN 60584-1.
- Note:** For TC wiring use proper compensating cable preferable shielded.

2.3.2 Infrared Sensor Input

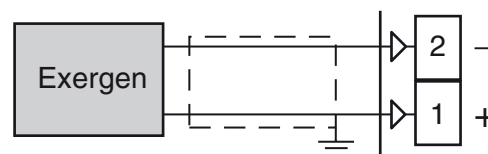

- External resistance:** Not relevant.
- Cold junction:** automatic Compensation between 0... 50°C.
- Cold junction accuracy:** 0.1°C/°C.
- Input impedance:** > 1 MΩ.

2.3.3 RTD Pt 100 Input

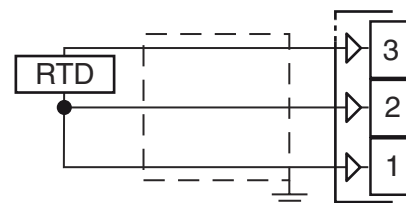

- Input circuit:** Current injection (150 μA).
- Line resistance:** Automatic compensation up to 20Ω/wire with maximum error ±0.1% of the input span.
- Calibration:** According to EN 60751/A2.
- Note:** The resistance of the 3 wires must be the same.

2.3.4 RTD Pt 1000, NTC and PTC Input

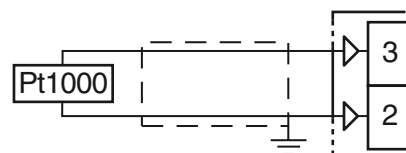

- Line resistance:** Not compensated.
- Pt 1000 input circuit:** Current injection (15 μA).
- Pt 1000 calibration:** According to EN 60751/A2.

2.3.5 V and mV Input

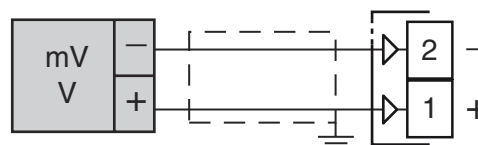

- Input impedance:** > 1 MΩ for mV Input
500 kΩ for Volt Input.

2.3.6 mA Input

0/4... 20 mA input wiring for passive transmitter using the auxiliary pws

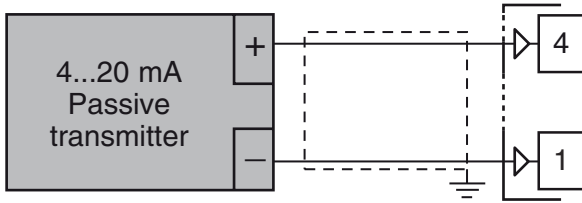

Input impedance: $< 53\Omega$.

Internal auxiliary PWS: 12 VDC ($\pm 10\%$), 20 mA max..

0/4... 20 mA input wiring for passive transmitter using an external pws

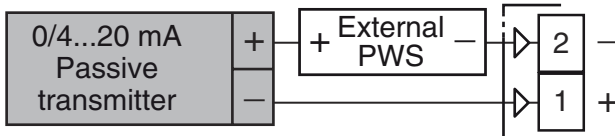

0/4... 20 mA input wiring for active transmitter

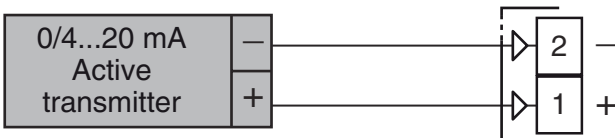

2.3.7 Logic Inputs

Safety notes:

- Do not run logic input wiring together with power cables;
- The instrument needs 150 ms to recognize a contact status variation;
- Logic inputs are **NOT** isolated by the measuring input. A double or reinforced isolation between logic inputs and power line must be assured by the external elements.

Logic input driven by dry contact

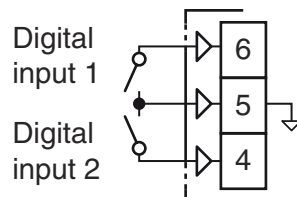

Maximum contact resistance: 100Ω .

Contact rating: DI1 = 10 V, 6 mA;
DI2 = 12 V, 30 mA.

Logic inputs driven by 24 VDC

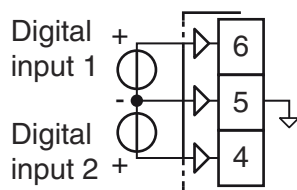

Logic status 1: 6... 24 VDC;

Logic status 0: 0... 3 VDC.

2.4 Outputs

Safety notes:

- To avoid electrical shocks, connect power line at last.
- For supply connections use No. 16 AWG or larger wires rated for at least 75°C .
- Use copper conductors only.
- SSR outputs are not isolated. A reinforced isolation must be assured by the external solid state relays.
- For SSR, mA and V outputs if the line length is longer than 30 m use a shielded wire.



Before connecting the output actuators, we recommend to configure the parameters to suit your application (e.g.: input type, Control strategy, alarms, etc.).

2.4.1 Output 1 (OP1)

Relay Output

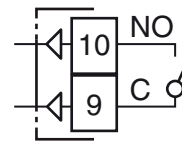

Contact rating: • 4 A /250 V $\cos\phi = 1$;
• 2 A /250 V $\cos\phi = 0.4$.

Operation: 1×10^5 .

SSR Output

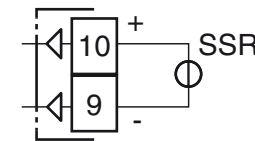

Logic level 0: $V_{out} < 0.5 \text{ VDC}$;

Logic level 1: 12 V $\pm 20\%$, 15 mA max..

Current Analogue Output

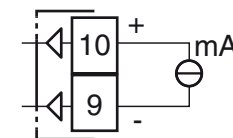

mA output: 0/4... 20 mA, galvanically isolated, maximum load resistance: 500Ω .

Voltage Analogue Output

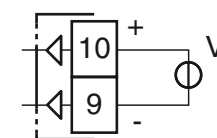

mA output: 0/2... 10 V, galvanically isolated, minimum load resistance: 500Ω .

2.4.2 Output 2 (OP2)

Relay Output

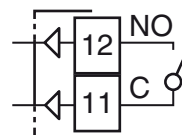

Contact rating: • 2 A /250 V $\cos\phi = 1$;
• 1 A /250 V $\cos\phi = 0.4$.

Operation: 1×10^5 .

SSR Output

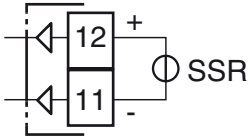

Logic level 0: $V_{out} < 0.5 \text{ VDC}$;
Logic level 1: $12 \text{ V} \pm 20\%$, 15 mA max..

2.4.3 Output 3 (OP3)

Relay Output

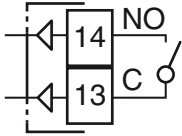

Contact rating: • 2 A /250 V $\cos\phi = 1$;
 • 1 A /250 V $\cos\phi = 0.4$.

Operation: 1×10^5 .

SSR Output

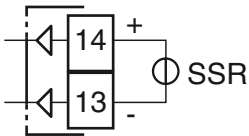

Logic level 0: $V_{out} < 0.5 \text{ VDC}$;
Logic level 1: $12 \text{ V} \pm 20\%$, 15 mA max..

2.4.4 Output 2 and Output 3 Servomotor Drive

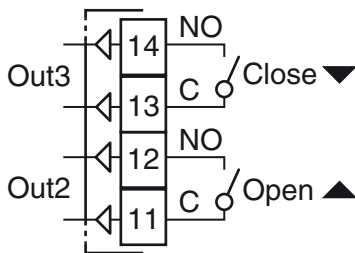

OP2/3 contact rating: • 2 A /250 V $\cos\phi = 1$;
 • 1 A /250 V $\cos\phi = 0.4$.

Operation: 1×10^5 .

2.4.5 Output 4 (OP4)

SSR Output

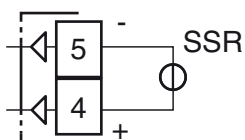

Logic level 0: $V_{out} < 0.5 \text{ VDC}$;
Logic level 1: $12 \text{ V} \pm 20\%$, 20 mA max..

Note: Overload protected.

2.5 Serial Interface

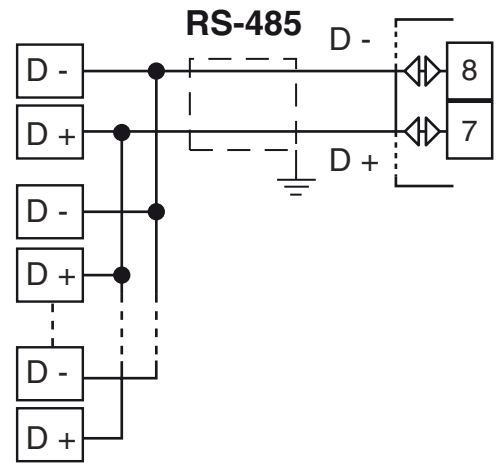

Interface type: Isolated (50 V) RS-485;
Voltage levels: According to EIA standard;
Protocol type: MODBUS RTU;
Byte format: 8 bit with no parity;
Stop bit: 1 (one);
Baud rate: Programmable between 1200... 38400 baud;
Address: Programmable between 1... 255.
Notes: 1. RS-485 interface allows to connect up to 30 devices with one remote master unit.
 2. The cable length must not exceed 1.5 km at 9600 baud.

2.6 Power Supply

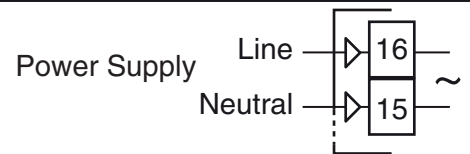

Supply Voltage: • 24 VAC/DC ($\pm 10\%$);
 • 100... 240 VAC (-15... +10%).

Notes: 1. Before connecting the instrument to the power line, make sure that line voltage is equal to the voltage shown on the identification label;
 2. The polarity of the power supply has no importance;
 3. The power supply input is NOT fuse protected. Please, provide a T type 1A, 250 V fuse externally.
 4. When the instrument is powered by the A01 key, the outputs are NOT supplied and the instrument can show the "ouLd" (Out 4 Overload) indication.

3.1 Technical specifications

Case: Plastic, self-extinguishing degree: V-0 according to UL 94;

Front protection: IP 65 (when the optional panel gasket is mounted) for indoor locations according to EN 60070-1;

Terminals protection: IP 20 according to EN 60070-1;

Installation: Panel mounting;

Terminal block: 16 M3 screw terminals for cables of 0.25... 2.5 mm² (AWG22... AWG14) with connection diagram;

Dimensions: 48 x 96, depth 75.9 mm, (1.77 x 3.78 x 2.99 in.)

Panel cutout: 45(+0.6) x 89(+0.6) mm [1.78(+0.023) x 3.5(+0.023) in.]

Weight: 160 g max..

Power supply: • 24 VAC/DC ($\pm 10\%$ of the nominal value);
• 100... 240 VAC (-15% ... $+10\%$ of the nominal value);

Power consumption: 5 VA max.;

Insulation voltage: 3000 V rms according to EN 61010-1;

Display updating time: 500 ms;

Sampling time: 130 ms;

Resolution: 30000 counts;

Total Accuracy: $\pm 0.5\%$ F.S.V. ± 1 digit @ 25°C of room temperature;

Electromagnetic compatibility and safety requirements

Compliance: directive EMC 2004/108/CE (EN 61326-1), directive LV 2006/95/CE (EN 61010-1);

Installation category: II;

Pollution category: 2;

Temperature drift: It is part of the global accuracy;

Operating temperature: 0... 50°C (32... 122°F);

Storage temperature: -30... +70°C (-22... +158°F);

Humidity: 20... 85% RH, not condensing.

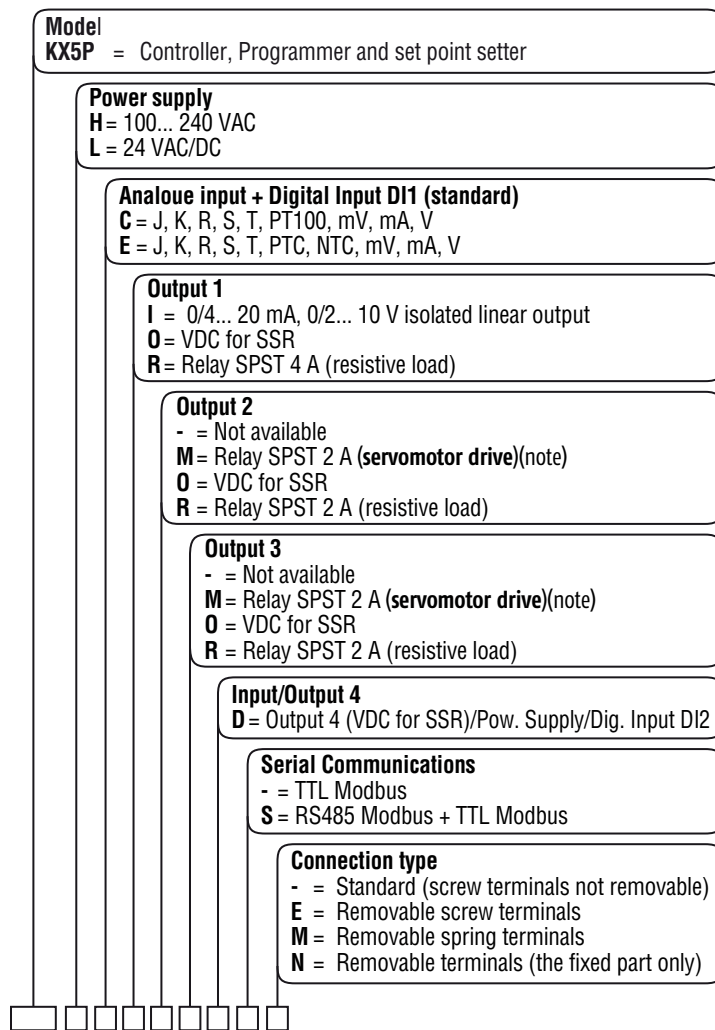

Note: For servomotor drive, both **Output 2** and **Output 3** codes must be selected as “**M**”.

5.1 Introduction

When the instrument is powered, it starts immediately to work according to the parameters values loaded in its memory.

The instrument behaviour and its performance are governed by the value of the stored parameters.

At the first start up the instrument will use a “default” parameter set (factory parameter set); this set is a generic one (e.g. a TC J input is programmed).



Before connecting the output actuators, we recommend to configure the parameters to suit your application (e.g.: input type, Control strategy, alarms, etc.).

To change these parameters you need to enter the “Configuration mode”.

Note: An engineering unit change (parameter [5] unit) **does NOT produce the automatic re-scaling** of all parameters related with the engineering unit.



5.2 Instrument behaviour at Power ON

At power ON the instrument can start in one of the following mode depending on its configuration:

Auto mode without program functions.

- The upper display will show the measured value;
- The lower display will show the Set point value;
- The decimal figure of the less significant digit of the upper display is OFF;
- The instrument is performing the standard closed loop control.

Manual mode (OPLO).

- The upper display will show the measured value;
- The lower display will show the power output and the MAN LED will lite;
- The instrument does not perform Automatic control;
- The control output is equal to 0% and can be manually modified by  and  buttons.

Stand-by mode (St.bY).

- The upper display will show the measured value;
- The lower display will show alternately the set point value and the message *St.bY* or *od*;
- The instrument does not perform any control (the control outputs are OFF);
- The instrument is working as an indicator.

Auto mode with automatic program start up.



- The upper display will show the measured value;
- The lower display will show one of the following information;
 - The operative set point (when it is performing a ramp)
 - The time of the segment in progress (when it is performing a soak);

NOTE VERY WELL: In all cases, the decimal figure of the less significant digit of the lower display is lit.

We define all the above described conditions as “**Standard Display**”.

5.3 How to enter the “Configuration mode”

The configuration parameters are collected in various groups. Every group defines all parameters related with a specific function (e.g.: control, alarms, output functions).

1. Push the  button for more than 5 seconds.
The upper display shows *PASS* while the lower display shows *0*.
2. Using  and  buttons set the programmed password.

Notes:

1. The factory default password for configuration parameters is equal to 30.
2. During parameter modification the instrument continues to control the process.
In certain conditions, when a configuration change can produce a heavy bump to the process, it is advisable to temporarily stop the control during the programming operations (the control output will be Off). In this case, use a password equal to 2000 + the programmed value (e.g. 2000 + 30 = 2030).
The control will restart automatically when the configuration procedure will be manually closed.

3. Push the  button.

If the password is correct the display will show the acronym of the first parameter group preceded by the symbol: .









In other words the upper display will show:  *INP*
(group of the **Input parameters**).

The instrument is in configuration mode.

5.4 How to exit the “Configuration mode”

Push  button for more than 5 seconds, the instrument will come back to the “standard display”.

5.5 Keyboard functions during parameter changing

-  A short pression on the button exits from the current parameter group and selects a new parameter group. A long pression allows to close the configuration parameter procedure (the instrument returns to the “standard display”).
-  When the upper display is showing a group and the lower display is blank, this key allows to enter in the selected group.
When the upper display is showing a parameter and the lower display is showing its value, this key allows to store the selected value for the current parameter and access the next parameter within the same group.
-  Increases the value of the selected parameter.
-  Decreases the value of the selected parameter.
-  +  These two keys allow to return to the previous group. Proceed as follows:
Push the  button and maintaining the pressure, push the  button; release both the buttons.

Note: The group selection is cyclic as well as the selection of the parameters in a group.

5.6 Factory reset - default parameters loading procedure

Sometime, e.g. when you re-configure an instrument previously used for other works (or by other people) or when you have made too many errors during configuration and you decided to re-configure the instrument, it is possible to restore the factory configuration.

This action allows to put the instrument in a defined condition (the same it was at the first power ON).

The default data are those typical values loaded in the instrument prior to ship it from factory.

To load the factory default parameter set, proceed as follows:

1. Press the button for more than 5 seconds;
2. The upper display will show *PRSS* while the lower display shows ;
3. Using and buttons set the value *-48*;
4. Push button;
5. The instrument will turn OFF all LEDs for a few seconds, then the upper display will show *dFLt* (default) and after that all LEDs are turned ON for 2 seconds.

At this point the instrument restarts as for a new power ON.

The procedure is complete.

Note: The complete list of the default parameters is available in **Appendix A**.

5.7 Parameters configuration

In the following pages we will describe all the instrument parameters. However, the instrument will only show those parameters applicable to the hardware options in accordance with the specific instrument configuration (i.e.: setting *RL It* [Alarm 1 type] to *nonE* [not used], all parameters related to alarm 1 will be skipped).

inP Group - Main and auxiliary input configuration

[1] SEnS - Input type

Available: Always.

Range: • When the code of the input type is equal to **C** (see “How to order” paragraph).

J	TC J	(0... 1000°C/32... 1832°F);
crAL	TC K	(0... 1370°C/32... 2498°F);
S	TC S	(0... 1760°C/32... 3200°F);
r	TC R	(0... 1760°C/32... 3200°F);
t	TC T	(0... 400°C/32... 752°F);
n	TC N	(0... 1000°C/32... 1832°F);
ir.J	Exergen IRS J	(0... 1000°C/32... 1832°F);
ir.cA	Exergen IRS K	(0... 1370°C/32... 2498°F);
Pt1	RTD Pt 100	(-200... 850°C/-328... 1562°F);
Pt10	RTD Pt 1000	(-200... 850°C/-328... 1562°F);
0.60	0... 60 mV linear;	
12.60	12... 60 mV linear;	
0.20	0... 20 mA linear;	
4.20	4... 20 mA linear;	
0.5	0... 5 V linear;	
1.5	1... 5 V linear;	
0.10	0... 10 V linear;	
2.10	2... 10 V linear.	

- When the code of the input type is equal to **E** (see “How to order” paragraph).

J	TC J	(0... 1000°C/32... 1832°F);
crAL	TC K	(0... 1370°C/32... 2498°F);
S	TC S	(0... 1760°C/32... 3200°F);
r	TC R	(0... 1760°C/32... 3200°F);
t	TC T	(0... 400°C/32... 752°F);
n	TC N	(0... 1000°C/32... 1832°F);
ir.J	Exergen IRS J	(0... 1000°C/32... 1832°F);
ir.cA	Exergen IRS K	(0... 1370°C/32... 2498°F);
Ptc	PTC	(-55... 150°C/-67... 302°F);
ntc	NTC	(-50... 110°C/-58... 230°F);
0.60	0... 60 mV linear;	
12.60	12... 60 mV linear;	
0.20	0... 20 mA linear;	
4.20	4... 20 mA linear;	
0.5	0... 5 V linear;	
1.5	1... 5 V linear;	
0.10	0... 10 V linear;	
2.10	2... 10 V linear.	

- Notes:**
1. When a TC or RTD input is selected and a decimal figure is programmed (see the next parameter) the max. displayed value becomes 999.9°C or 999.9°F.
 2. All changes to SEnS parameter setting will force the [2] dP = 0 and it will change all parameters related with dP (e.g. set points, proportional band, etc.).

[2] dP - Decimal point position

Available: Always.

Range: When [1] SenS = Linear input: 0... 3.

When [1] SenS different from linear input: 0 or 1.

Note: All changes to decimal point position will produce a change to all the parameters related with it (e.g.: set points, proportional band, etc.).

[3] SSc - Initial scale read-out for linear inputs

Available: When a linear input is selected by [1] SenS.

Range: -1999... 9999.

- Notes:**
1. SSc defines, for linear inputs, the value that is to be displayed when the instrument measures the minimum measurable value. The instrument is able to display the measured value until it reaches a value of 5% lower than SSc, below which shows the Underrange message.
 2. It is possible to set an initial scale read-out higher than the full scale read-out in order to obtain a reverse read-out scaling.
E.g.:
0 mA = 0 mBar and 20 mA = -1000 mBar (vacuum).

[4] FSc - Full scale read-out for linear input

Available: When a linear input is selected by [1] SenS.

Range: -1999... 9999

- Notes:**
1. FSc defines, for linear inputs, the value that is to be displayed when the instrument measures the maximum measurable value. The instrument is able to display the measured value until it reaches a value of 5% higher than FSc, above which shows the Overrange message.
 2. It is possible to set a full scale read-out lower than the initial scale read-out in order to obtain a reverse read-out scaling.
E.g.:
0 mA = 0 mBar and 20 mA = -1000 mBar (vacuum).

[5] unit - Engineering unit

Available: When a temperature sensor is selected by [1] SenS parameter.

Range: °C Celsius;
°F Fahrenheit.

Note: An engineering unit modification does NOT produce the automatic re-scaling of all parameters related with the engineering unit (e.g. alarm thresholds, proportional band, etc.).

[6] FiL - Digital filter on the measured value

Available: Always.

Range: oFF (No filter) 0.1 to 20.0 s

Note: This is a first order digital filter applied on the measured value. For this reason it will affect the measured value but also the control action and the alarms behaviour.

[7] inE - Selection of the Sensor Out of Range type that will enable the safety output value

Available: Always.

Range: our When an overrange or an underrange is detected, the power output will be forced to the value of [8] oPE parameter.
or When an overrange is detected, the power output will be forced to the value of [8] oPE parameter.
ur When an underrange is detected, the power output will be forced to the value of [8] oPE parameter.

[8] oPE - Safety output value

Available: Always.

Range: -100... 100 % (of the output).

Notes: 1. When the instrument is programmed with one control action only (heat or cool), setting a value outside of the available output range, the instrument will use Zero. **E.g.:** When heat action only has been programmed, and oPE is equal to -50% (cooling) the instrument will use the zero value.
2. When ON/OFF control is programmed and an out of range is detected, the instrument will perform the safety output value using a fixed cycle time equal to 20 seconds.

[9] io4.F - I/O4 function selection

Available: Always.



Range: on Out 4 forced to ON (used as a transmitter power supply);
out4 Used as digital output 4;
dG2.c Digital input 2 for dry contact;
dG2.U Digital input 2 driven by 12... 24 VDC.

Notes: 1. Setting [9] io4.F = dG2.C or dG2.V, the parameter [24] O4F becomes not visible while [11] diF2 parameter becomes visible.
2. Setting [9] io4F = on the [24] O4F parameter and the [11]diF2 parameter will NOT be visible.
3. Setting [9] io4F different from dG2.c or dG2.U, the instrument forces [12] diF2 parameter to *nonE*. If [11] diF1 was equal to (SP4 or UPDN) it will be forced to *nonE*.
4. The transfer from [9] io4F = on to [9] io4F = Out4 makes parameter [24] O4F visible equal to *nonE*.

[10] diF1 - Digital input 1 function

Available: Always.

Range: oFF No function;



- 1 Alarm Reset [status];
- 2 Alarm acknowledge (ACK) [status];
- 3 Hold of the measured value [status];
- 4 Stand by mode of the instrument [status].
When the contact is closed the instrument operates in stand by mode;
- 5 Manual mode;
- 6 Program Run [transition].
The first closure allows to start program execution but a second closure restart the program execution from the beginning;
- 7 Program Reset [transition].
A contact closure allows to reset program execution;
- 8 Program Hold [transition].
The first closure allows to hold program execution and a second closure continue program execution;
- 9 Program Run/Hold [status]. When the contact is closed the program is running.;
- 10 Program Run/Reset [status]:
 - Contact closed - Program run;
 - Contact open - Program reset;
- 11 SP1/SP2 selection [status];
- 12 Binary selection of the set point made by digital input 1 (less significant bit) and digital input 2 (most significant bit) [status];
- 13 Digital input 1 will work in parallel with  button while digital input 2 will work in parallel with the  button.

[11] diF2 - Digital input 2 function

Available: When [9] io4.F = diG2.

Range: oFF No function;

- 1 Alarm Reset [status];
- 2 Alarm acknowledge (ACK) [status];
- 3 Hold of the measured value [status];
- 4 Stand by mode of the instrument [status].
When the contact is closed the instrument operates in stand by mode;
- 5 Manual mode;
- 6 Program Run [transition].
The first closure allows to start program execution but a second closure restart the program execution from the beginning;
- 7 Program Reset [transition].
A contact closure allows to reset program execution;
- 8 Program Hold [transition].
The first closure allows to hold program execution and a second closure continue program execution;
- 9 Program Run/Hold [status]. When the contact is closed the program is running;
- 10 Program Run/Reset [status]:
 - Contact closed - Program run;
 - Contact open - Program reset;
- 11 SP1/SP2 selection [status];
- 12 Binary selection of the set point made by digital input 1 (less significant bit) and digital input 2 (most significant bit) [status];

- 13 Digital input 1 will work in parallel with the  button while digital input 2 will work in parallel with the  button.

- Notes:**
- When [10] diF1 = 12, [11] diF2 setting is forced to 12 and diF2 cannot perform another function.
 - When [10] diF1 = 12 and [11] diF2 = 12, the set point selection will be in accordance with the following table:

Dig In1	Dig. In2	Operative set point
Off	Off	Set point 1
On	Off	Set point 2
Off	On	Set point 3
On	On	Set point 4

- When [10] diF1 is equal to 13, [11] diF2 setting is forced to up.du (13 value) and cannot perform another function.

[12] di.A - Digital Inputs Action

Available: Always.

Range: 0	D11 Direct action, D12 (if configured) Direct action;
1	D11 Reverse action, D12 (if configured) Direct action;
2	D11 Direct action, D12 (if configured) Reverse action;
3	D11 Reverse action, D12 (if configured) Reverse action.

3 out Group - Output parameters

[13] o1.t - Out 1 type

Available: When Out1 is a linear output.

Range: 0-20	0... 20 mA
4-20	4... 20 mA
0-10	0... 10 V
2-10	2... 10 V

[14] o1.F - Out 1 function

Available: Always.

Range: • When Out 1 is a linear output:

nonE	Output not used. With this setting the status of this output can be driven directly from serial link;
H.rEG	Heating output;
c.rEG	Cooling output.
r.inP	Analogue retransmission of the measured value;
r.Err	Analogue retransmission of the measured error (PV-SP);
r.SP	Analogue retransmission of the operative set point;
r.SEr	Analogue retransmission of a value coming from serial link;
• When out 1 is a digital output (relay or SSR):	
nonE	Output not used. With this setting the status of this output can be driven directly from serial link;
H.rEG	Heating output;
c.rEG	Cooling output;
AL	Alarm output;
P.End	Program end indicator;
P.HLd	Program hold indicator;
P. uit	Program wait indicator;

P.run	Program run indicator;
P.Et1	Program Event 1;
P.Et2	Program Event 2;
or.bo	Out-of-range or burn out indicator;
P.FAL	Power failure indicator;
bo.PF	Out-of-range, Burnout and Power failure indicator;
St.By	Stand By status indicator;
diF1	Repeats the digital input 1 status;
diF2	Repeats the digital input 2 status;
on	Out1 always ON;
riSP	Inspection request.

- Notes:**
- When two or more outputs are programmed in the same way, these outputs will be driven in parallel.
 - The power failure indicator will be reset when the instrument detect an alarm reset command by  key, digital input or serial link.
 - When no control output is programmed, all the relative alarm (when present) will be forced to nonE (not used).

[15] A.o1L - Initial scale value of the analogue retransmission

Available: When Out 1 is a linear output and [14] O1F is equal to r.IMP, r.Err, r.SP or r.SEr

Range: -1999 to [16] Ao1H.

[16] A.o1H - Full scale value of the analogue retransmission

Available: When Out 1 is a linear output and [14] O1F is equal to r.IMP, r.Err, r.SP or r.SEr.

Range: [15] Ao1L to 9999.

[17] o1.AL - Alarms linked up with the out 1

Available: When [14] o1F = AL.

Range: 0... 63 with the following rules:

+1	Alarm 1;
+2	Alarm 2;
+4	Alarm 3;
+8	Loop break alarm;
+16	Sensor break (burn out);
+32	Overload on Out 4 (short circuit on the Out4).

Example 1: Setting 3 (2+1) the output will be driven by the alarm 1 and 2 (OR condition).

Example 2: Setting 13 (8+4+1) the output will be driven by alarm 1 + alarm 3 + loop break alarm.

[18] o1.Ac - Out 1 action

Available: When [14] o1F is different from nonE.

Range: dir	Direct action;
rEU	Reverse action;
dir.r	Direct action with revers LED indication;
rEU.r	Reverse action with reverse LED indication.

- Notes:**
- Direct action: the output repeats the status of the driven element.
Example: the output is an alarm output with direct action. When the alarm is ON, the relay will be energized (logic output 1).
 - Reverse action: the output status is the opposite of the status of the driven element.
Example: the output is an alarm output with reverse action. When the alarm is OFF, the relay will be energized (logic output 1). This setting is usually named "fail-safe" and it is generally used in

dangerous process in order to generate an alarm when the instrument power supply goes OFF or the internal watchdog starts.

[19] o2F - Out 2 function

Available: When the instrument has out 2 option.

Range: nonE Output not used. With this setting the status of this output can be driven directly from serial link;

H.rEG	Heating output;
c.rEG	Cooling output;
AL	Alarm output;
P.End	Program end indicator;
P.HLd	Program hold indicator;
P.uit	Program wait indicator;
P.run	Program run indicator;
P.Et1	Program Event 1;
P.Et2	Program Event 2;
or.bo	Out-of-range or burn out indicator;
P.FAL	Power failure indicator;
bo.PF	Out-of-range, Burnout and Power failure indicator;
St.By	Stand By status indicator;
diF1	Repeats the digital input 1 status;
diF2	Repeats the digital input 2 status;
on	Out2 always ON;
riSP	Inspection request.

For other details see [14] O1F parameter.



When a servomotor control is desired, **both Out2 and Out3** are to be selected as Heating or Cooling (**o2F = o3F = HrEG or o2F = o3F = crEG**). Parameter **[56] cont** must be set as **3PE**.

[20] o2.AL - Alarms linked up with Out 2

Available: When [19] o2F = AL.

Range: 0... 63 with the following rule:

+1	Alarm 1;
+2	Alarm 2;
+4	Alarm 3;
+8	loop break alarm;
+16	Sensor break (burn out);
+32	Overload on Out 4 (short circuit on OP4).

For more details see [17] o1.AL parameter.

[21] o2Ac - Out 2 action

Available: When [19] o2F is different from nonE.

Range: dir Direct action;
 rEU Reverse action;
 dir.r Direct action with revers LED indication;
 rEU.r Reverse action with reverse LED indication.

For more details see [18] o1.Ac parameter.

[22] o3F - Out 3 function

Available: When the instrument has out 3 option.

Range: nonE Output not used. With this setting the status of this output can be driven directly from serial link;

H.rEG	Heating output;
c.rEG	Cooling output;
AL	Alarm output;
P.End	Program end indicator;
P.HLd	Program hold indicator;
P.uit	Program wait indicator;
P.run	Program run indicator;
P.Et1	Program Event 1;

P.Et2	Program Event 2;
or.bo	Out-of-range or burn out indicator;
P.FAL	Power failure indicator;
bo.PF	Out-of-range, Burnout and Power failure indicator;
St.By	Stand By status indicator;
diF1	Repeats the digital input 1 status;
diF2	Repeats the digital input 2 status;
on	Out3 always ON;
riSP	Inspection request.



When a servomotor control is desired, **both Out2 and Out3** are to be selected as Heating or Cooling (**o2F = o3F = HrEG or o2F = o3F = crEG**). Parameter **[56] cont** must be set as **3PE**.

For other details see [14] O1F parameter.

[23] o3.AL - Alarms linked up with Out 3

Available: When [21] o3F = AL.

Range: 0... 63 with the following rule:

+1	Alarm 1;
+2	Alarm 2;
+4	Alarm 3;
+8	Loop break alarm;
+16	Sensor break (burn out);
+32	Overload on Out 4 (short circuit on OP 4).

For more details see [17] o1.AL parameter.

[24] o3Ac - Out 3 action

Available: When [20] o3F is different from nonE.

Range: dir Direct action;
 rEU Reverse action;
 dir.r Direct action with revers LED indication;
 rEU.r Reverse action with reverse LED indication.

For more details see [18] o1.Ac parameter.

[25] o4F - Out 4 function

Available: When the [9] io4.F = Out4.

Range: nonE Output not used. With this setting the status of this output can be driven directly from serial link;

H.rEG	Heating output;
c.rEG	Cooling output;
AL	Alarm output;
P.End	Program end indicator;
P.HLd	Program hold indicator;
P.uit	Program wait indicator;
P.run	Program run indicator;
P.Et1	Program Event 1;
P.Et2	Program Event 2;
or.bo	Out-of-range or burn out indicator;
P.FAL	Power failure indicator;
bo.PF	Out-of-range, Burnout and Power failure indicator;
St.By	Stand By status indicator;
diF1	Repeats the digital input 1 status;
diF2	Repeats the digital input 2 status;
on	Out4 always ON;
riSP	Inspection request.

For other details see [14] O1F parameter.

[26] o4.AL - Alarms linked up with Out 4

Available: When [24] o4F = AL.

Range: 0... 63 with the following rule:

- +1 Alarm 1;
- +2 Alarm 2;
- +4 Alarm 3;
- +8 Loop break alarm;
- +16 Sensor break (burn out);
- +32 Overload on Out 4 (short circuit on OP4).

For more details see [17] o1.AL parameter.

[27] o4Ac - Out 4 action

Available: When [25] o4F is different from nonE.

- Range:**
- dir Direct action;
 - rEU Reverse action;
 - dir.r Direct action with revers LED indication;
 - rEU.r Reverse action with reverse LED indication;

For more details see [18] o1.Ac parameter.

AL1 Group - Alarm 1 parameters

[28] AL1t - Alarm 1 type

Available: Always.

Range: • When one or more outputs are programmed as control output:

- nonE Alarm not used;
- LoAb Absolute low alarm;
- HiAb Absolute high alarm;
- LHAo Absolute band alarm with alarm indication out of the band;
- LHAI Absolute band alarm with alarm indication inside the band;
- SE.br Sensor break;
- LodE Deviation low alarm (relative);
- HidE Deviation high alarm (relative);
- LHdo Relative band alarm with alarm indication out of the band;
- LHdi Relative band alarm with alarm indication inside the band;

• When no output is programmed as control output:

- nonE Alarm not used;
- LoAb Absolute low alarm;
- HiAb Absolute high alarm;
- LHAo Absolute band alarm with alarm indication out of the band;
- LHAI Absolute band alarm with alarm indication inside the band;
- SE.br Sensor break.

Notes: 1. The relative and deviation alarms are “relative” to the operative set point value.

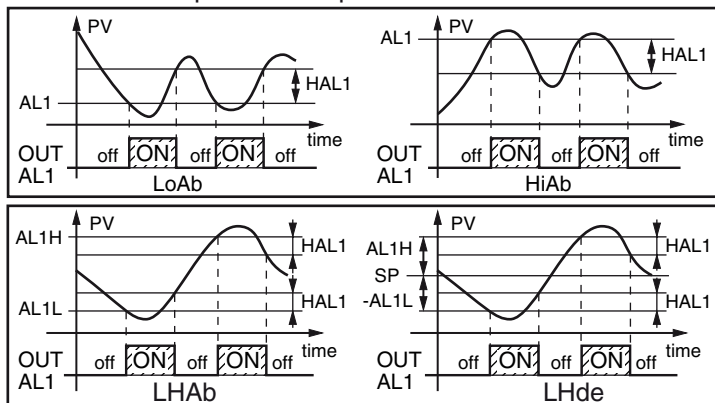

2. The (SE.br) sensor break alarm will be ON when the display shows ---- indication.

[29] Ab1 - Alarm 1 function

Available: When [28] AL1t is different from nonE.

Range: 0... 15 with the following rule:

- +1 Not active at power up;
- +2 Latched alarm (manual reset);
- +4 Acknowledgeable alarm;
- +8 Relative alarm not active at set point change.

Example: Setting Ab1 equal to 5 (1 + 4) the alarm 1 will be “not active at power up” and “Acknowledgeable”.

Notes: 1. The “not active at power up” selection allows to inhibit the alarm function at instrument power up or when the instrument detects a transfer from:

- Manual mode (oPLo) to auto mode;
- Stand-by mode to auto mode.

The alarm will be automatically enabled when the measured value reaches, for the first time, the alarm threshold ± hysteresis (in other words, when the initial alarm condition disappears).

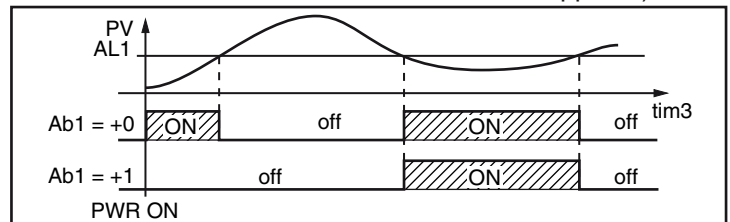

2. A “Latched alarm” (manual reset) is an alarm that will remain active even if the conditions that generated the alarm no longer persist. Alarm reset can be done only by an external command (☑ button, digital inputs or serial link).

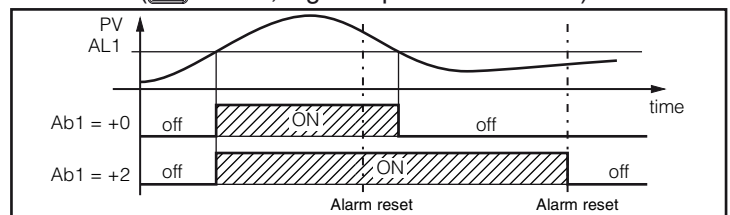

3. An “Acknowledgeable” alarm is an alarm that can be reset even if the conditions that generated the alarm are still present. Alarm acknowledge can be done only by an external command (☑ button, digital inputs or serial link).

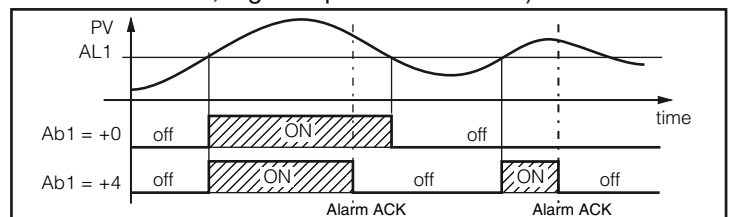

A “Relative alarm not active at set point change” is an alarm that masks the alarm condition after a set point change until process variable reaches the alarm threshold ± hysteresis.

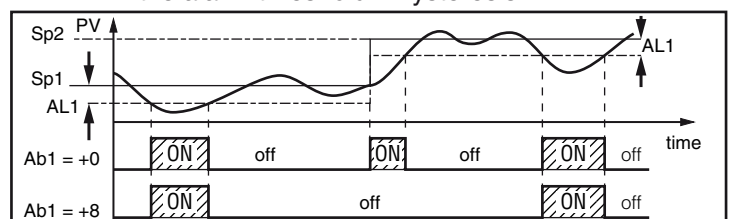

4. The instrument does not store in EEPROM the alarm status. For this reason, the alarm status will be lost if a power down occurs.

[30] AL1L - For High and low alarms, it is the low limit of the AL1 threshold

- For band alarm, it is low alarm threshold

Available: When [28] AL1t is different from nonE or [28] AL1t is different from SE.br.

Range: From -1999 to [30] AL1H engineering units.

[31] AL1H - For High and low alarms, it is the high limit of the AL1 threshold

- For band alarm is high alarm threshold

Available: When [28] AL1t is different from nonE or [28] AL1t is different from SE.br.

Range: From [30] AL1L to 9999 engineering units.

[32] AL1- Alarm 1 threshold

Available: When:

- [28] AL1t = LoAb - Absolute low alarm;
- [28] AL1t = HiAb - Absolute high alarm;
- [28] AL1t = LodE - Deviation low alarm (relative);
- [28] AL1t = LidE - Deviation high alarm (relative).

Range: From [30] AL1L to [31] AL1H engineering units.

[33] HAL1 - Alarm 1 hysteresis

Available: When [28] AL1t is different from nonE or [28] AL1t is different from SE.br.

Range: 1... 9999 engineering units

Notes: 1. The hysteresis value is the difference between the Alarm threshold value and the point the Alarm automatically resets.

2. When the alarm threshold plus or minus the hysteresis is out of input range, the instrument will not be able to reset the alarm.

Example: Input range 0... 1000 (mBar).

- Set point equal to 900 (mBar);
- Deviation low alarm equal to 50 (mBar);
- Hysteresis equal to 160 (mBar)
the theoretical reset point is $900 - 50 + 160 = 1010$ (mBar) but this value is out of range.
The reset can be made only by turning the instrument OFF, removing the condition that generates the alarm and then turn the instrument ON again.

- All band alarms use the same hysteresis value for both thresholds;

- When the hysteresis of a band alarm is bigger than the programmed band, the instrument will not be able to reset the alarm.

Example: Input range 0... 500 (°C).

- Set point equal to 250 (°C);
- Relative band alarm;
- Low threshold equal to 10 (°C);
- High threshold equal to 10 (°C);
- Hysteresis equal to 25 (°C).

[34] AL1d - Alarm 1 delay

Available: When [28] AL1t is different from nonE.

Range: From OFF (0) to 9999 seconds.

Note: The alarm goes ON only when the alarm condition persists for a time longer than [34] AL1d time but the reset is immediate.

[35] AL1o - Alarm 1 enabled during Stand-by mode and out of range indications

Available: When [28] AL1t is different from nonE.

Range: 0 Never;
1 During stand by;
2 During overrange and underrange;
3 During overrange, underrange and stand-by.

AL2 Group - Alarm 2 parameters

[36] AL2t - Alarm 2 type

Available: Always

Range: • When one or more outputs are programmed as control output:

nonE	Alarm not used;
LoAb	Absolute low alarm;
HiAb	Absolute high alarm;
LHAo	Absolute band alarm with alarm indication out of the band;
LHAi	Absolute band alarm with alarm indication inside the band;
SE.br	Sensor break;
LodE	Deviation low alarm (relative);
HidE	Deviation high alarm (relative);
LHdo	Relative band alarm with alarm indication out of the band;
LHdi	Relative band alarm with alarm indication inside the band;

• When no output is programmed as control output:

nonE	Alarm not used;
LoAb	Absolute low alarm;
HiAb	Absolute high alarm;
LHAo	Absolute band alarm with alarm indication out of the band;
LHAi	Absolute band alarm with alarm indication inside the band;
SE.br	Sensor break.

Note: The relative alarm are "relative" to the current set point (this may be different from the Target setpoint if you are using the ramp to set point function).

[37] Ab2 - Alarm 2 function

Available: When [36] AL2t is different from nonE.

Range: 0... 15 with the following rule:

+1	Not active at power up;
+2	Latched alarm (manual reset);
+4	Acknowledgeable alarm;
+8	Relative alarm not active at set point change.

Example: Setting Ad2 equal to 5 (1+4) the alarm 2 will be "Not active at power up" and "Acknowledgeable".

Note: For other details see [28] Ab1 parameter.

[38] AL2L - For High and low alarms, it is the low limit of the AL2 threshold

- For band alarm, is low alarm threshold

Available: When [36] AL2t is different from nonE or [36] AL2t is different from SE.br.

Range: -1999 to [39] AL2H engineering units.

[39] AL2H - For High and low alarms, it is the high limit of the AL2 threshold

- For band alarm is high alarm threshold

Available: When [36] AL2t is different from nonE or [36] AL2t is different from SE.br.

Range: From [38] AL2L to 9999 engineering units.

[40] AL2 - Alarm 2 threshold

Available: When:

- [36] AL2t = LoAb Absolute low alarm;
- [36] AL2t = HiAb Absolute high alarm;
- [36] AL2t = LodE Deviation low alarm (relative);
- [36] AL2t = LidE Deviation high alarm (relative);

Range: From [38] AL2L to [39] AL2H engineering units.

[41] HAL2 - Alarm 2 hysteresis

Available: When [36] AL2t is different to nonE or [36] AL2t is different from SE.br.

Range: 1... 9999 engineering units.

Note: For other details see [33] HAL1 parameter.

[42] AL2d - Alarm 2 delay

Available: When [36] AL2t different form nonE.

Range: From OFF (0) to 9999 seconds.

Note: The alarm goes ON only when the alarm condition persist for a time longer than [42] AL2d time but the reset is immediate.

[43] AL2o - Alarm 2 enabling during Stand-by mode and out of range indications

Available: When [36] AL2t different from nonE.

Range 0 Never;

- 1 During stand by;
- 2 During overrange and underrange;
- 3 During overrange, underrange and stand-by.

▯ AL3 Group - Alarm 3 parameters

[44] AL3t - Alarm 3 type

Available: Always.

Range: • When one or more outputs are programmed as control output:

- nonE Alarm not used;
- LoAb Absolute low alarm;
- HiAb Absolute high alarm;
- LHAo Absolute band alarm with alarm indication out of the band;
- LHAi Absolute band alarm with alarm indication inside the band;
- SE.br Sensor break;
- LodE Deviation low alarm (relative);
- HidE Deviation high alarm (relative);
- LHdo Relative band alarm with alarm indication out of the band;
- LHdi Relative band alarm with alarm indication inside the band;

• When no output is programmed as control output:

- nonE Alarm not used;
- LoAb Absolute low alarm;
- HiAb Absolute high alarm;
- LHAo Absolute band alarm with alarm indication out of the band;
- LHAi Absolute band alarm with alarm indication inside the band;
- SE.br Sensor break.

Note: The relative alarm are “relative” to the current set point (this may be different to the Target set point if you are using the ramp to set point function).

[45] Ab3 - Alarm 3 function

Available: When [43] AL3t is different from nonE.

Range: 0... 15 with the following rule:

- +1 Not active at power up.
- +2 Latched alarm (manual reset)
- +4 Acknowledgeable alarm
- +8 Relative alarm not active at set point change

Example: Setting Ad3 equal to 5 (1+4) the alarm 3 will be “Not active at power up” and “Acknowledgeable”.

Note: For other details see [29] Ab1 parameter.

[46] AL3L - For High and low alarms, it is the low limit of the AL3 threshold

- For band alarm is low alarm threshold

Available: When [44] AL3t is different from nonE or [44] AL3t is different from SE.br.

Range: -1999 to [47] AL3H engineering units.

[47] AL3H - For High and low alarms, it is the high limit of the AL3 threshold

- For band alarm is high alarm threshold

Available: When [44] AL3t is different from nonE or [44] AL3t is different from SE.br.

Range: From [46] AL3L to 9999 engineering units.

[48] AL3 - Alarm 3 threshold

Available: When:

- [44] AL3t = LoAb Absolute low alarm;
- [44] AL3t = HiAb Absolute high alarm;
- [44] AL3t = LodE Deviation low alarm (relative);
- [44] AL3t = LidE Deviation high alarm (relative).

Range: From [46] AL3L to [47] AL3H engineering units.

[49] HAL3 - Alarm 3 hysteresis

Available: When [44] AL3t is different to nonE or [44] AL3t is different from SE.br.

Range: 1... 9999 engineering units.

Note: For other details see [32] HAL1 parameter.

[50] AL3d - Alarm 3 delay

Available: When [44] AL3t different form nonE.

Range: From OFF (0) to 9999 seconds.

Note: The alarm goes ON only when the alarm condition persist for a time longer than [50] AL3d time but the reset is immediate.

[51] AL3o - Alarm 3 enabling during Stand-by mode and out of range indications

Available: When [44] AL3t is different from nonE or [44] AL3t is different from SE.br.

Range 0 Never;

- 1 During stand by;
- 2 During overrange and underrange;
- 3 During overrange, underrange and stand-by.

▯ LbA group - Loop break alarm

General note about LBA alarm

The LBA operate as follows: applying the 100% of the power output to a process, the process variable, after a time due to the process inertia, begins to change in a known direction (increases for an heating action or decreases for a cooling action).

Example: If I apply 100% of the power output to a furnace, the temperature must go up unless one of the component in the loop is faulty (heater, sensor, power supply, fuse, etc.).

The same philosophy can be applied to the minimum power. In our example, when I turn OFF the power to a furnace, the temperature must go down, if not the SSR is in short circuit, the valve is jammed, etc..

LBA function is automatically enabled when the PID requires the maximum or the minimum power.

When the process response is slower than the programmed limit the instrument generates an alarm.

- Notes:**
1. When the instrument is in manual mode, the LBA function is disabled.
 2. When LBA alarm is ON the instrument continues to perform the standard control. If the process response comes back into the programmed limit, the instrument automatically resets the LBA alarm.
 3. This function is available only when the programmed control algorithm is equal to PID (Cont = PID).

[52] LbAt - LBA time

Available: When [56] Cont = PID

- Range:**
- oFF = LBA not used;
 - 1... 9999 seconds.

[53] LbSt - Delta measure used by LBA during Soft start

Available: When [52] LbAt is different from oFF.

- Range:**
- oFF = loop break alarm is inhibit during soft start
 - 1... 9999 engineering units.

[54] LbAS - Delta measure used by loop break alarm (loop break alarm step)

Available: When [52] LbAt is different from oFF.

Range: From 1 to 9999 engineering units.

[55] LbCA - Condition for LBA enabling

Available: When [52] LbAt is different from oFF.

- Range:**
- | | |
|------|---|
| uP | Enabled when the PID requires the maximum power only; |
| dn | Enabled when the PID requires the minimum power only; |
| both | Enabled in both condition (when the PID requires the maximum or the minimum power). |

LBA application example:

LbAt (LBA time) = 120 seconds (2 minutes);

LbAS (delta LBA) = 5°C.

The machine has been designed in order to reach 200°C in 20 minutes (20°C/min).

When the PID demands 100% power, the instrument starts the time count.

During time count if the measured value increases more than 5°C, the instrument restarts the time count. Otherwise if the measured value does not reach the programmed delta (5°C in 2 minutes) the instrument will generate the alarm.

3rEG group - Control parameters

The rEG group will be available only when at least one output is programmed as control output (H.rEG or C.rEG).

[56] cont - Control type:

Available: When at least one output is programmed as control output (H.rEG or C.rEG).

Range: When two control action (heat & cool) are programmed:

- | | |
|-----|---|
| Pid | PID (heat and cool); |
| nr | Heat/Cool ON/OFF control with neutral zone. |

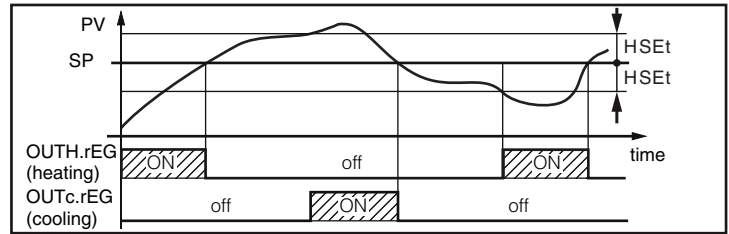

When one control action (heat or cool) is programmed:

- | | |
|-------|---|
| Pid | PID (heat or cool); |
| On.FA | ON/OFF asymmetric hysteresis; |
| On.FS | ON/OFF symmetric hysteresis; |
| 3Pt | Servomotor control (available when Output 2 and Output 3 have been ordered as "M"). |



When a servomotor control is desired, **both Out2 and Out3** are to be selected as Heating or Cooling (**o2F = o3F = HrEG** or **o2F = o3F = crEG**). Parameter **[56] cont** must be set as **3Pt**.

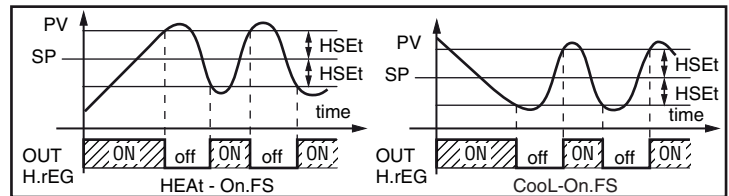
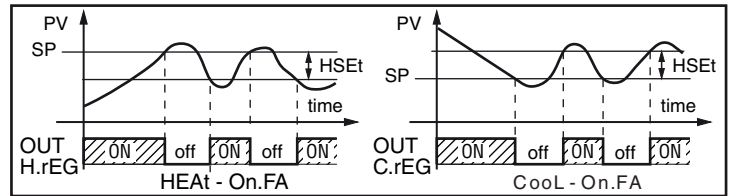

Notes: 1. ON/OFF control (heating action) with asymmetric hysteresis:

- OFF when $PV \geq SP$;
- ON when $PV \leq (SP - \text{hysteresis})$.

2. ON/OFF control (heating action) with symmetric hysteresis:

- OFF when $PV \geq (SP + \text{hysteresis})$;
- ON when $PV \leq (SP - \text{hysteresis})$.

[57] Auto - Auto tune selection

Ascon Tecnologic has developed three auto-tune algorithms:

- Oscillating auto-tune;
- Fast auto-tune;
- EvoTune.

1. The **oscillating** auto-tune is the usual auto-tune and:

- It is more accurate;
- Can start even if PV is close to the set point;
- Can be used even if the set point is close to the ambient temperature.

2. The **fast type** is suitable when:

- The process is very slow and you want to be operative in a short time;
- When an overshoot is not acceptable;
- In multi loop machinery where the fast method reduces the calculation error due to the effect of the other loops.

3. The **EvoTune** type is suitable when:

- You have no information about your process;
- You can not be sure about the end user skills;
- You desire an auto tune calculation independently from the starting conditions (e.g. set point change during tune execution, etc).

Note: Fast auto-tune can start only when the measured

value (PV) is lower than (SP + 1/2SP).

Available: When [56] cont = PID

Range: -4... 8 where:

- 4 Oscillating auto-tune with automatic restart at all set point change;
- 3 Oscillating auto-tune with manual start;
- 2 Oscillating auto-tune with automatic start at the first power up only;
- 1 Oscillating auto-tune with automatic restart at every power up;
- 0 Not used;
- 1 Fast auto tuning with automatic restart at every power up;
- 2 Fast auto-tune with automatic start at the first power up only;
- 3 FAST auto-tune with manual start;
- 4 FAST auto-tune with automatic restart at all set point change.
- 5 EvoTune with automatic restart at every power up;
- 6 EvoTune with automatic start at the first power up only;
- 7 EvoTune with manual start;
- 8 EvoTune with automatic restart at all set point change.

Note: All auto-tunes are inhibited during program execution.

[58] tunE - Manual start of the auto-tune

Available: When [56] cont = PID.

Range: oFF The instrument is not performing the auto-tune;
on The instrument is performing the auto-tune.

[59] HSEt - Hysteresis of the ON/OFF control

Available: When [56] cont is different from PID.

Range: 0... 9999 engineering units.

[60] Pb - Proportional band

Available: When [56] cont = PID.

Range: 1... 9999 engineering units.

Note: Auto-tune functions calculate this value.

[61] ti - Integral time

Available: When [56] cont = PID.

Range: OFF Integral action excluded;
1... 9999 seconds;
inF Integral action excluded.

Note: Auto-tune functions calculate this value.

[62] td - Derivative time

Available: When [56] cont = PID.

Range: oFF - derivative action excluded;
1... 9999 seconds.

Note: Auto-tune functions calculate this value.

[63] Fuoc - Fuzzy overshoot control

This parameter reduces the overshoot usually present at instrument start up or after a set point change and it will be active only in this two cases.

Setting a value between 0.00 and 1.00 it is possible to slow down the instrument action during set point approach.

Setting **Fuoc = 1** this function is disabled.

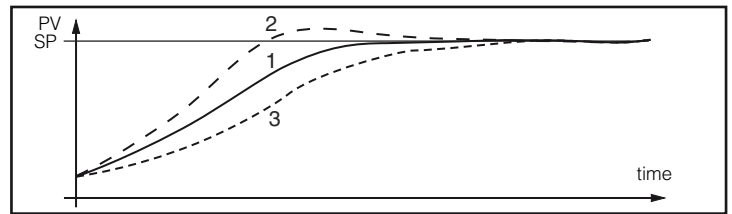

Available: When [56] cont = PID

Range: 0... 2.00.

Note: Fast auto-tune calculates the Fuoc parameter while the oscillating one sets it equal to 0.5.

[64] tcH - Cycle time of the heating output

Available: When at least one output is programmed in order to be the heating output (H.rEG), [56] cont = PID

Range: 1.0... 130.0 seconds.

[65] rcG - Power ratio between heating and cooling action (relative cooling gain)

The instrument uses the same PID parameter set for heat and for cool action but the efficiency of the two actions is usually different.

This parameter allows to define the ratio between the efficiency of the heating system and the efficiency of the cooling one.

An example will help us to explain the philosophy.

Consider one loop of a plastic extruder. The working temperature is equal to 250°C.

When you want to increase the temperature from 250 to 270°C ($\Delta T = 20^\circ\text{C}$) using 100% of the heating power (resistor), you will need 60 seconds.

On the contrary, when you want to decrease the temperature from 250 to 230°C ($\Delta T = 20^\circ\text{C}$) using 100% of the cooling power (fan), you will need 20 seconds only.

In our example the ratio is equal to $60/20 = 3$ ([65] rcG = 3) and it says that the efficiency of the cooling system is 3 times more efficient of the heating one.

Available: When two control actions are programmed (H.rEG and c.rEG) and [55] cont = PID.

Range: 0.01... 99.99.

Note: Auto-tune functions calculate this value.

[66] tcc - Cycle time of the cooling output

Available: When at least one output is programmed in order to be the cooling output (c.rEG), [56] cont = PID.

Range: 1.0... 130.0 seconds.

[67] rS - Manual reset (integral pre-load)

It allows to drastically reduce the undershoot due to a hot restart. When your process is steady, the instrument operates with a steady power output (e.g.: 30%).

If a short power down occurs, the process restarts with a process variable close to the set point while the instrument starts with an integral action equal to zero.

Setting a manual reset equal to the average power output (in our example 30%) the instrument will start with a power output equal to the value it will use at steady state (instead of zero) and the undershoot will become very little (in theory equal to zero).

Available: When [56] cont = PID.

Range: -100.0... +100.0%.

[68] Str.t - Servomotor stroke time

Available: When [56] cont = 3Pt.

Range: 5... 1000 seconds.

[69] db.S - Servomotor dead band

Available: When [56] cont = 3Pt.

Range: 0... 100%.

[70] od - Delay at power up

Available: When at least one output is programmed as control output.

Range: oFF Function not used;
0.01... 99.59 hh.mm.

- Notes:**
1. This parameter defines the time during which (after a power up) the instrument remains in stand by mode before to start all other functions (control, alarms, program, etc.).
 2. When a program with automatic start at power up and "od" function are programmed, the instrument performs "od" function before to start the program execution.
 3. When an auto-tune with automatic start at power up and "od" function are programmed, the autotune will start at the end of "od" delay.

[71] St.P - Max. power output used during soft start

Available: When at list one output is programmed as control output.

Range: -100... +100%.

- Notes:**
1. When St.P parameter have a positive value, the limit will be applied to the heating output(s) only.
 2. When St.P parameter have a negative value, the limit will be applied to the cooling output(s) only.
 3. When a program with automatic start at power up and soft start function are programmed, the instrument performs the soft start and than the program function.
 4. The auto-tune function will be performed after soft start function.
 5. The Soft start function is available also when ON/OFF contro l is used.

[72] SSt - Soft start time

Available: When at list one output is programmed as control output.

Range: oFF Function not used;
0.01... 7.59 hh.mm;
inF soft start always active.

[73] SS.tH - Threshold for soft start disabling

Available: When at list one output is programmed as control output.

Range: -1999... 9999 engineering units.

- Notes:**
1. When the power limiter have a positive value (the limit is applied to the heating action) the soft start function will be aborted when the measured value is greater or equal to SS.tH parameter.
 2. When the power limiter have a negative value (the limit is applied to the cooling action) the soft start function will be aborted when the measured value is lower or equal to SS.tH parameter.

SP Group - Set point parameters

The SP group will be available only when at least one output is programmed as control output (H.rEG or C.rEG).

[74] nSP - Number of used set points

Available: When at least one output is programmed as control output.

Range: 1... 4.

Note: When you change the value of this parameter, the instrument operates as follows:

- [81] A.SP parameter will be forced to SP.
- The instrument verifies that all used set point are within the limits programmed by [76] SPLL end [77] SPHL. If an SP is out of this range, the instrument forces it to the maximum acceptable value.

[75] SPLL - Minimum set point value

Available: When at least one output is programmed as control output.

Range: From -1999 to [76] SPHL engineering units.

- Notes:**
1. When you change the [75] SPLL value, the instrument checks all local set points (SP, SP2, SP3 and SP4 parameters) and all the program set points ([95] Pr.S1, [100] Pr.S2, [105] Pr.S3, [110] Pr.S4 parameters). If an SP is out of this range, the instrument forces it to the max. acceptable value.
 2. A [75] SPLL change produces the following actions:
 - When [82] SP.rt = SP the remote set point will be forced to be equal to the active set point;
 - When [82] SP.rt = trim the remote set point will be forced to zero;
 - When [82] SP.rt = PErc the remote set point will be forced to zero.

[76] SPHL - Maximum set point value

Available: When at least one output is programmed as control output.

Range: From [75] SPLL to 9999 engineering units.

Note: For other details see [75] SPLL parameter.

[77] SP - Set Point 1

Available: When at least one output is programmed as control output.

Range: From [75] SPLL to [76] SPHL engineering units.

[78] SP 2 - Set Point 2

Available: When at least one output is programmed as control output and [74] nSP \geq 2.

Range: From [75] SPLL to [76] SPHL engineering units.

[79] SP 3 - Set Point 3

Available: When at least one output is programmed as control output and [74] nSP \geq 3.

Range: From [75] SPLL to [76] SPHL engineering units.

[80] SP 4 - Set Point 4

Available: When at least one output is programmed as control output and [74] nSP =4.

Range: From [75] SPLL to [76] SPHL engineering units.

[81] A.SP - Selection of the active Set point

Available: When at least one output is programmed as control output.

Range: From "SP" to [74] nSP.

- Notes:**
1. A [81] A.SP change produces the following actions:
 - When [82] SP.rt = SP - the remote set point

- will be forced to be equal to the active set point;
- When [82] SP.r_t = trin - the remote set point will be forced to zero;
- When [82] SP.r_t = PErc - the remote set point will be forced to zero.

2. SP2, SP3 and SP4 selection will be shown only when the relative set point is enabled (see [74] nSP parameter).

[82] SP.r_t - Remote set point type

These instruments will communicate with each other, using RS 485 serial interface without a PC. An instrument can be set as a Master while the other are Slave units. The Master unit can send his operative set point to the slave units.

In this way, for example, it is possible to change simultaneously the set point of 20 instruments by changing the set point of the master unit (e.g. hot runner application).

SP.r_t parameter defines how the slaves units will use the value coming from serial link.

Parameter [100] tr.SP [selection of the value to be retransmitted (Master)] parameter allows to define the value sent by master unit.

Available: When at least one output is e programmed as control output and the serial interface is present.

Range: rSP	The value coming from serial link is used as remote set point (RSP);
trin	The value coming from serial link will be algebraically added to the local set point selected by A.SP and the sum becomes the operative set point;
PErc	The value coming from serial will be scaled on the input range and this value will be used as remote set point.

Note: A [82] SP.r_t change produces the following actions:

- When [82] SP.r_t = rSP - the remote set point will be forced to be equal to the active set point;
- When [82] SP.r_t = trin - the remote set point will be forced to zero;
- When [82] SP.r_t = PErc - the remote set point will be forced to zero.

Example: A 6 zone reflow-oven for PCB.

The master unit sends its set point value to 5 other zones (slave controllers).

The Slave zones use it as a set point trim.

The first zone is the master zone and it uses a set point equal to 210°C.

The second zone has a local set point equal to -45°C.

The third zone has a local set point equal to -45 (°C).

The fourth zone has a local set point equal to -30.

The fifth zone has a local set point equal to +40.

The sixth zone has a local set point equal to +50.

In this way, the thermal profile will be the following:

- Master SP = 210°C;
- Second zone SP = 210 -45 = 165°C;
- Third zone SP = 210 -45 = 165°C;
- Fourth zone SP = 210 - 30 = 180°C;
- Fifth zone SP = 210 + 40 = 250°C;
- Sixth zone SP = 210 + 50 = 260°C.

Changing the SP of the master unit, all the other slave units will immediately change their operative set point.

[83] SPLr - Local/remote set point selection

Available: When at list one output is programmed as control output.

Range: Loc	Local set point selected by [81] A.SP;
rEn	Remote set point (coming from serial link).

[84] SP.u - Rate of rise for positive set point change (ramp up)

Available: When at list one output is e programmed as control output.

Range: 0.01... 99.99	units per minute;
inF	ramp disabled (step transfer).

[85] SP.d - Rate of rise for negative set point change (ramp down)

Available: When at list one output is e programmed as control output.

Range: 0.01... 99.99	units per minute;
inF	ramp disabled (step transfer).

General note about remote set point: when the remote set point (RSP) with trim action is programmed, the local set point range becomes the following:
from [75] SP.LL+ RSP to [76] SP.HL - RSP.

3 PAn group - Operator HMI

[86] PAS2 - Level 2 password: Limited access level

Available: Always.

Range: oFF = Level 2 not protected by password (as level 1 = Operator level);
1... 200.

[87] PAS3 - Level 3 password: Complete configuration level

Available: Always.

Range: 3... 200.

Note: Setting [86] PAS2 equal to [87] PAS3, the level 2 will be masked.

[88] uSrb - button function during RUN TIME

Available: Always.

Range: nonE	No function;
tunE	Auto-tune/self-tune enabling. A single press (longer than 1) starts the auto-tune;
oPLo	Manual mode. The first pressure puts the instrument in manual mode (OPLo) while a second one puts the instrument in Auto mode;
AAc	Alarm reset;
ASi	Alarm acknowledge;
chSP	Sequential set point selection (see note);
St.by	Stand by mode. The first press puts the instrument in stand by mode while a second one puts the instrument in Auto mode;
P.run	Program run (see note);
P.rES	Program reset (see note);
P.r.H.r	Program run/hold/reset (see note). When "Program run" is selected, the first press starts the program execution but a second press restarts the program execution from the beginning.

Notes: 1. When "Program reset" is selected, a short press resets the program execution.

- When "Program run/hold/reset" is selected, a short press starts/stop (Hold) the program execution while a long press (longer than 10 seconds) resets the program.

[89] diSP - Display management

Available: Always.

Range: nonE	Standard display;
Pou	Power output;
PoS =	Valve position (servomotor control);
SPF	Final set point;
Spo	Operative set point;
AL1	Alarm 1 threshold;
AL2	Alarm 2 threshold;
AL3	Alarm 3 threshold;
Pr.tu =	During a soak, the instrument shows the elapsed time of the soak;
	<ul style="list-style-type: none"> During a ramp the display shows the operative set point; At the end of the program execution, the instrument shows "P.End" messages alternately with the measured value; When no program is running, the instrument will show the standard display;
Pr.td	During a soak, the instrument will show the remaining time of the soak (count down);
	<ul style="list-style-type: none"> During a ramp the display will show the operative set point; At the end of the program execution, the instrument shows <i>P_End</i> message alternately with the measured value; When no program is running, the instrument will show the standard display.;
P.t.tu	When the programmer is running, the display shows the total elapsed time. At the end of the program execution, the instrument show <i>t_End</i> message alternately with the measured value;
P.t.td	When the programmer is running, the display shows the total remaining time (count down). At the end of the program execution, the instrument shows <i>P_End</i> message alternately with the measured value;
PERc	Percent of the power output used during soft start (when the soft start time is equal to infinite, the limit is ever active and it can be used also when ON/OFF control is selected).

[90] di.CL - Display colour

Available: Always.

Range: 0	The display colour is used to show the actual deviation (PV - SP);
1	Display red (fix);
2	Display green (fix);
3	Display orange (fix).

[91] AdE - Deviation for display colour management

Available: When [90] di.CL = 0.

Range: 1... 9999 engineering units.

[92] diS.t - Display time out

Available: Always.

Range: oFF The display is always ON;
0.1... 99.59 minutes and seconds.

Note: This function allows to turn OFF the display when no alarm is present and no action is made on the instrument.

When diS.t is different from OFF and no button is pressed for more than the programmed time out, the display goes OFF and only 4 segments of the less significant digit are turned ON in sequence in order to show that the instrument is working correctly. If an alarm occurs or a button is pressed, the display returns to the normal operation.

[93] FiLd - Filter on the displayed value

Available: Always.

Range: 0.0 oFF (Filter disabled);
0.1... 20.0 in engineering units.

Note: This is a "window filter" related to the set point, it is applied to the displayed value only and it have no effect on the other functions of the instrument (control, alarms, etc.).

[94] bG.F - Bargraph function

Available: Always.

Range: nonE	Bargraph not lit;
Pou	Output power calculated by PID (single action: 0... 100%, double action: -100... +100%);
PoS	Valve position (servomotor control);
Pr.tu	Elapsed time of the program in execution;
Pr.td	Time to end of the program in execution;
Pr.tS	Time to end of the program segment in execution;

Note: Displaying values using the bar graph is possible only if the variables involved are configured. If it has been chosen to display the time of the program; the bargraph is off if the option is not configured; has the first LED lit if the option is configured but not running.

[95] dSPu - Instrument Status at power up

Available: Always.

Range: AS.Pr	Starts in the same way it was prior to the power down;
Auto	Starts in Auto mode;
oP.0	Starts in manual mode with a power output equal to zero;
St.bY	Starts in stand-by mode.

- Notes:**
- When you change the value of [96] oPr.E, the instrument forces [97] oPEr parameter equal to Auto.
 - During program execution the instrument stores the segment currently in use and, by a 30 minutes interval, it stores also the elapsed time of the soak. If a power down occurs during program execution, at the next power up the instrument is able to continue the program execution starting from the segment in progress at power down and, if the segment was a soak, it is also capable to restart from the soak time minus the stored elapsed time. In order to obtain this features, the "[95] dSPu - Status of the instrument at power up" parameter must be set to "AS.Pr".

If the "[95] dSPu" parameter is different from "AS.Pr" the storing function is inhibited.

[96] oPr.E - Operative modes enabling

Available: Always.

Range: ALL	All modes will be selectable by the next parameter.
Au.oP	Auto and manual (oPLo) mode only will be selectable by the next parameter.

Au.Sb Auto and Stand-by modes only will be selectable by the next parameter.

Note: Changing the value of [96] oPr.E, the instrument forces [97] oPEr parameter to Auto.

[97] oPEr - Operative mode selection

Available: Always.

Range:

- When [96] oPr.E = ALL:
Auto Auto mode;
oPLo Manual mode;
St.bY Stand by mode.
- When [96] oPr.E = Au.oP:
Auto Auto mode;
oPLo Manual mode.
- When [96] oPr.E = Au.Sb:
Auto Auto mode;
St.bY Stand by mode.

3 Ser group - Serial link parameter

[98] Add - Instrument address

Available: Always.

Range: oFF Serial interface not used;
1... 254.

[99] bAud - Baud rate

Available: When [98] Add different from oFF.

Range: 1200 1200 baud;
2400 2400 baud;
9600 9600 baud;
19.2 19200 baud;
38.4 38400 baud.

[100] trSP - Selection of the value to be retransmitted (Master)

Available: When [98] Add different from oFF.

Range: nonE Retransmission not used (the instrument is a slave);
rSP The instrument becomes a Master and retransmits the operative set point;
PErc The instrument becomes a Master and retransmits the power output.

Note: For more details see [82] SP.rt (Remote set point type) parameter.

3 CAL group - User calibration group

This function allows to calibrate the complete measuring chain and to compensate the errors due to:

- Sensor location;
- Sensor class (sensor errors);
- Instrument accuracy.

[101] AL.P - Adjust Low Point

Available: Always.

Range: -1999... (AH.P - 10) engineering units.

Note: The minimum difference between AL.P and AH.P is equal to 10 Engineering Units.

[102] ALo - Adjust Low Offset

Available: Always.

Range: -300... +300 engineering units.

[103] AH.P - Adjust High Point

Available: Always.

Range: From (AL.P + 10) to 9999 engineering units.

Note: The minimum difference between AL.P and AH.P is equal to 10 Engineering Units.

[104] AH.o - Adjust High Offset

Available: Always.

Range: -300... +300 Engineering Units.

Example: Environmental chamber with 10... 100°C of operative range.

1. Insert in the chamber a reference sensor connected with a reference instrument (usually a calibrator).
2. Start the control of the instrument, and set a set point equal to the minimum value of the operative range (e.g.: 10°C). When the temperature in the chamber is steady, take note of the temperature measured by the reference system (e.g.: 9°C).
3. Set [138] AL.P = 10 (low working point) and [139] ALo = -1 (the difference between the reading of the instrument and the reading of the reference system). Note that after this set, the measured value of the instrument is equal to the measured value of the reference system.
4. Set a set point equal to the maximum value of the operative range (e.g.: 100°C). When the temperature in the chamber is steady, take note of the temperature measured by the reference system (e.g.: 98°C).
5. Set [140] AH.P = 100 (low working point) and [141] AHo = +2 (the difference between the reading of the instrument and the reading of the reference system). Note that after this set, the measured value of the instrument is equal to the measured value of the reference system.

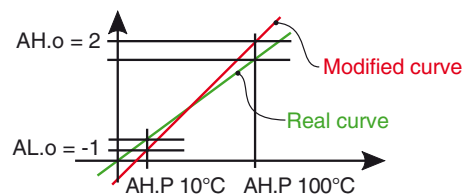

Note: Parameters from [105] to [125] are reserved.

3 PrG Group - Programmer function parameters

These instruments are equipped with 2 pages of 4 program each (8 programs total).

Each program is composed by 6 groups of 2 steps each (12 steps total)

The first step is a ramp (used to reach the desired set point), the second is a soak (on the desired set point).

When a RUN command is detected the instrument aligns the operative set point to the measured value and starts to execute the first ramp of the selected program.

When you need a program with more than 12 segments it is possible to link the selected program with the next one.

Example:

You are preparing the Page 1, Program 1 but you need 20 steps.

At the end of the 12 segments of Program 1 you will find a parameter "[164] P1.c2 – Program 1 continue on Program 2"; setting YES you will link Program 1 with Program 2.

Now you can program the 8 steps (of Program 2) necessary to complete your profile.

Running Program 1, the instrument performs the first program followed by the 8 steps of program 2.

In addition, every soak is equipped with a wait band which suspends the time count when the measured value goes out of the defined band (guaranteed soak).

Moreover, for each segment it is possible to define the status of two events. An event can drive an output and make an action during one or more specific program steps.

Some additional parameters allow to define the time scale, the automatic RUN conditions, the repetition number and the instrument behaviour at the end of the program.

- Notes:**
1. All steps can be modified during program execution.
 2. During program execution the instrument stores the segment currently in use and, by a 1 minute interval, it stores also the elapsed time of the soaks.

If a power down occurs during program execution, at the next power up the instrument is able to continue the program execution starting from the segment in progress at power down and, if the segment was a soak, it is also capable to restart from the soak time minus the elapsed time memorized.

In order to obtain this features, the [95] dSPu "Status of the instrument at power up" parameter must be set to *ASPr*.

If [95] dSPu value is different from *ASPr*, the storing function will be inhibited.

The structure of the programmer parameters is based on:



- 1 group with the "global" parameters [PrG group](page selection, active program selection status of the active program, etc.).
- 1 group for every program (Page 1: Pr1, Pr2, Pr3 and Pr4 and Page 2: Pr5, Pr6, Pr7, Pr8).

NOTE VERY WELL:

In chapter 8 we will described all parameters related with the programmer and their action during program execution.

5.8 How to exit from parameter configuration

When all the important steps of the configuration procedure are completed, it is possible to exit from the parameters configuration procedure:

- Push  button.
- Push  button for more than 10 s. The instrument returns back to the "standard display".

6 PARAMETER PROMOTION

Another important step of the instrument configuration is caused by the possibility to create a custom HMI (interface) in order to make the instrument easy to use for the operator and comfortable for the assistance.

By a special procedure, named promotion, the OEM can create two parameter subsets.

The first one is the "limited access" level. This subset is protected by the password programmed by [86] PAS2 parameter.

The last subset is the "Operator" set (Level1). This level is NOT password protected.

- Notes:**
1. The "limited access" parameter are collected in a list;
 2. The elements of the "limited access" parameters are programmable and can be made according to your needs.
 3. The parameter list of the operator level is the same programmed for "limited access" level but only specified parameters can be displayed and modified. This set must be create according to your requirements.

6.1 Parameter promotion procedure

The limited access parameter set is a list and it is a subset of the configuration parameters.

Before to start the promotion procedure, we suggest to operate as follows:

1. Prepare the exact parameter list you want to make accessible for limited access.
2. Define which of the selected parameters must be available also at Operator level.







Example: I would like to obtain the following limited access list:

- AL1 - Alarm 1 threshold;
- AL2 - Alarm 2 threshold;
- SP - First set point;
- SP2 - Second set point;
- A.SP - Set point selection;
- tunE - Manual start of the auto-tune.

But I want that the operator will be able to change: the SP value and the AL1 value. In this case the promotion list is:

Parameter	Promotion	Limited Access	Operator
- AL1 -	oPEr	AL1	AL1
- AL2 -	ASS	AL2	
- SP -	oPEr	SP	SP
- SP2 -	ASS	SP2	
- A.SP-	ASS	A.SP	
- tunE -	ASS	Tune	

Now, proceed as follows:

1. Push the  button for more than 3 seconds.
2. The upper display shows *PASS* while the lower display shows .
3. By  and  buttons set a password equal to *-81*.
4. Push  button.
The instrument displays the acronym of the first configuration parameter group *PrG*.
5. Press the  button to select the group of the first parameter of your list.
6. Press the  button to select the first parameter of your list.

7. The upper display shows the acronym of the parameter while the lower display its current promotion level.

The promotion level is defined by a message.

The possible values are:

CONF: The parameter is **NOT** promoted and is present only in configuration.



In this case the number is forced to zero.

ASS: The parameter has been promoted to the limited access level.

The number indicates the position in the limited access list.

oPEr: The parameter has been promoted to the Operator level.

The number indicates the position in the limited access list.

8. By  and  buttons assign to this parameter the desired level.
9. Select the second parameter that you want to add to the assistance level and repeat step 6, 7 and 8.
10. Repeat step 5, 6, 7, 8 until the list has been completed.
11. When you need to exit from promotion procedure, push  button and maintain the pressure for more than 10 s. The instrument returns back to the “standard display”.

Example: In the previous example, I have set for SP1 a promotion value equal to *ASS*.

If now I set for SP1 a promotion value equal to *oPEr*, the Limited Access list and the Operator list become.

Parameter	Promotion	Limited Access	Operator
- AL1 -	oPEr	AL1	AL1
- AL2 -	ASS	AL2	
- SP -	oPEr	SP	SP
- SP2 -	oPEr	SP2	SP2
- A.SP-	ASS	A.SP	
- tunE -	ASS	Tune	

7 OPERATIVE MODES

As we said at paragraph 5.1, when the instrument is powered, it starts immediately working in accordance to the stored parameter value.

In other words, the instrument has one status only, the “run time” status.

During “run time” we can force the instrument to operate in three different modes: Automatic mode, Manual mode or Stand by mode:

- In **Automatic mode** the instrument drives automatically the control output according to the parameter value set and the set point/measured value.
 - In **Manual mode** the upper display shows the measured value while the lower display shows the power output, the MAN LED is ON and the instrument allows to set manually the control output power.
No Automatic action will be made.
 - In **Stand by mode** the instrument operates as an indicator. It shows on the upper display the measured value and on the lower display the set point alternately to the “St.bY” message and forces the control outputs to zero.
- As we have seen, it is always possible to modify the value assigned to a parameter independently from the operative mode selected.

7.1 Modify a parameter during “Operator level”









Preliminary note: The parameters available at operator level (but also at limited access level) are divided into two parameter “families”: Standard parameters (*PRr*) and programs parameters (*Pr oG*).

The standard parameters family is a list and includes the parameters usually present in a standard controller (e.g. Set point, alarm threshold, Proportional band, etc..).

Programs parameters are divided into groups (PrG, Pr1, Pr2, Pr3 and Pr4). The first one (PrG) includes the parameters necessary to manage the program running (or to select the program to run), while the other includes all editing parameters related with a specific program (Pr1 for program 1, etc.).

When the operator desires to edit a parameter, the instrument asks to select the “family” to be displayed (*U ,S*) and then to choose the parameter.







The instrument is showing the “standard display”.

1. Press the  button.
2. The upper display shows *U ,S* while the lower displays *PRr*.
3. By  and  buttons select *PRr*.
4. Press the  button.
5. The upper display shows the acronym of the first parameter promoted to this level while the lower display shows its value.
6. By  and  buttons assign to this parameter the desired value.
7. Press the  button in order to store the new value and go to the next parameter.
8. To return to the “standard display” push the  button for more than 5 seconds.

Note: The parameter modification of the Operator level is subject to a time out. If no button is pressed for more than 10 seconds, the instrument returns to the “standard display” and the new value of the last selected parameter will be lost.

7.2 Enter the “Limited access level”

The instrument is showing the “standard display”.

1. Press the  button for more than 5 seconds;
2. The upper display shows *PASS* while the lower *0*;
3. By  and  buttons set the value assigned to [86] PAS2 (Level 2 password).
4. The upper display shows *U 15* while the lower displays *PR-*.
5. By  and  buttons select *PR-*.
6. Press the  button.
7. The upper display will show the acronym of the first parameter promoted to this level while the lower display will show its value.

- Notes:**
1. The factory default password for configuration parameters is equal to 20.
 2. Parameter modifications are protected by a time out. If no button is pressed for more than 10 s the instrument returns automatically to the Standard display, the new value of the last selected parameter is lost and the parameter modification procedure is closed.

To remove the time out (e.g. the first time an instrument is configured), use a password equal to 1000 plus the programmed password (e.g. 1000 + 20 [default] = 1020).

It is always possible to manually end the parameter configuration procedure (see below).







3. During parameter modification the instrument continues to perform the control.

In certain conditions (e.g. when a parameter change produces a heavy bump to the process) it is advisable to temporarily stop the control procedure during the programming session (the control output will be Off). A password equal to 2000 + the programmed value (e.g. 2000 + 20 = 2020) switches to off the control output during the configuration procedure. The control automatically restarts when the parameter modification procedure will be manually ended.

7.3 How to see but not modify the “limited access parameters”





Sometimes it is necessary to give to the operator the possibility to see the value assigned to the parameter promoted in the Limited Access level but it is important that all changes are made by authorized personnel only.

In this cases, proceed as follows:

1. Press the  button for more than 5 seconds;
2. The upper display will show *PASS* while the lower display will show *0*;
3. By  and  buttons set the value - *1B 1*;
4. Push  button;
5. The upper display will show the acronym of the first parameter promoted to the level 2 and lower display will show its value;
6. Using  button it is possible to see the value assigned to all the parameters present in level 2 but the values cannot be modified;
7. It is possible to return to the “standard display” pushing the  button for more than 3 seconds or by pushing no buttons for more than 10 seconds.

7.4 Automatic Mode

7.4.1 Keyboard function when the instrument is in Auto mode

-  Performs the action programmed by [88] uSrb ( button function during RUN TIME) parameter.
-  Allows to enter into parameter modification procedures.
-  Allows to start the “Direct set point modification” function (see below).
-  Allows to display the “additional informations” (see below).



7.4.2 Direct set point modification

This function allows to modify rapidly the set point value selected by [81] A.SP (selection of the active Set point) or to the set point of the segment group (of the programmer) currently in progress.

The instrument is showing the “standard display”.

1. Push  button.
The upper display shows the acronym of the selected set point (e.g. SP2) and the lower display its value;

Note: When the programmer is running, the instrument shows the set point of the soak currently in execution (e.g. if the instrument is performing the soak 3 of the program 2, the instrument will show P2.S3).

2. By  and  buttons, assign to this parameter the desired value
3. Do not push any button for more than 5 second or push the  button.



In both cases the instrument stores the new value and returns to the “standard display”.

Note: If the selected set point has not been promoted to the Operator level, the instrument allows to see the value but not to modify it.

7.5 Manual mode

This operative mode allows to deactivate the automatic control and manually program the percentage power output to applied to the the process.

When the instrument is in manual mode, the upper display shows the measured value while the lower display shows alternately the power output [preceded by *H* (for heating action) or *C* (for cooling action)] and the message $\square PL \square$ (open loop).

When manual control is selected, the instrument starts to operate with the same power output as the last one supplied by automatic mode and can be modified using the  and  buttons.

In case of ON/OFF control, 0% corresponds to the deactivated output while any value different from 0 corresponds to the activated output.

As in the case of visualization, the programmable values range from H100 (100% output power with reverse action) to C100 (100% output power with direct action).

- Notes:**
1. During manual mode, the alarms are operative.
 2. If you set manual modes during program execution, the program will be frozen and it will restart when the instrument will come back to Auto mode.
 3. If you set manual modes during self-tune execution, the self-tune function will be aborted.
 4. During manual mode, all functions not related with the control (wattmeter, independent timer, “worked time”, etc) continue to operate normally.

7.6 Stand by mode

This operative mode also deactivates the automatic control but forces the control output to zero.

In this mode the instrument operates as an indicator.









When the instrument is in stand by mode the upper display shows the measured value while the lower display alternatively shows the set point and the message “St.bY”.

- Notes:**
1. During stand by mode, relative alarms are disabled while absolute alarms are operative or not according to the ALx0 (Alarm x enabling during Stand-by mode) parameter setting.
 2. If you set stand by mode during program execution, the program will be aborted.
 3. Setting the stand by mode during self-tune execution, the self-tune function will be aborted.
 4. During stand by mode, all functions not related with the control (wattmeter, independent timer, “worked time”, etc.) continue to operate normally.
 5. When the instrument is swapped from stand by to auto mode, it automatically starts the alarm masking, the soft start functions and auto-tune (if programmed).

7.6.1 Additional information

This instrument is able to show some additional information that can help managing the system.

The additional information are related to how the instrument is programmed, hence in many cases, only part of this information is available.

1. When the instrument is showing the “standard display” push  button.
The lower display shows *H* or *C* followed by a number. This value is the current power output applied to the process.
H means Heating action while
C means Cooling action.
2. Push  button again. The lower display shows the program page currently selected. Example “PAGE 2”;
3. Push  button again. The lower display shows the selected program number. Example: “PrG7”= program 7;
4. Push  button again. When the programmer is running the lower display shows the program and the segment currently in execution. **NOTE:** When linked programs are running, the program selected and the program in execution can be different Example: “P7.S1”= program 7 soak 1;
5. Push  button again. When the programmer is running the lower display shows the time remaining for this program to the end of the current cycle.
Example: “12.22” = 12 minutes and 22 seconds;
6. Push  button again. When the programmer is running the lower display shows the already made executions.
Example: “E . 5” = 5 executions are already made;
7. Push  button again. When the programmer is running the lower display shows the Event status.
Example: “EU.01” => event 1 = 0 - Event 2 = 1;
8. Push  button again. The instrument returns to the “standard display”.

Note: The additional information visualization is subject to a time out. If no button is pressed for more than 10 seconds the instrument automatically returns to the Standard display.

7.6.2 Display management

This instrument allows to program (see parameter [92] diS.t the time out of the display.

This function allows to turn OFF the display when no alarm is present and no action is made on the instrument.

When [92] diS.t is different from OFF (display always ON) and no button is pressed for more than the programmed time out, the display goes OFF and only the four segments of the less significant digit are turned ON in sequence in order to show that the instrument is working correctly.

If an alarm occurs or a button is pressed, the display returns to normal operation.

7.6.3 Display Colour Shows the Deviation

This instrument allows to program the deviation (PV - SP) for colour display change (see parameter [123] AdE).

In this way the upper display colour will be:

- Amber when PV is lower than SP - AdE;
- Green when (SP - AdE) < PV < SP + AdE;
- Red when PV is higher than SP + AdE.

8.1 How to Edit (create or modify) a program

Preliminary note: As already described, the parameters available at operator level (but also at limited access level) are divided into two parameter “families”.

Each Program parameters family is divided in 5 groups (PrG , $Pr1$, $Pr2$, $Pr3$ and $Pr4$ or PrG , $Pr5$, $Pr6$, $Pr7$ and $Pr8$). The first one (PrG) includes the parameter necessary to manage the program running (or to select the program to run), while the other includes all editing parameters related with a specific program ($Pr1$ for program 1, etc.).

These instruments are equipped with 8 programs divided into 2 pages of 4 programs each.

For this reason we have Program 1 to program 4 when page 1 is selected and Program 5 to 8 when page 2 is selected.

To select a program:

- Enter in PrG group;
- Select the desired “page”;
- Select the desired “program”.

$\supset PrG$ Group - Programmer function parameters

[126] PAGE = Selection of the active program page

Available: Always.

Range: 1 or 2

Note: During program execution this parameter can NOT be changed.

[127] Pr.n = Active program

Available: Always.

Range: From 1 to 8.

Note: During program execution this parameter can NOT be changed.











[128] Pr.St – Status of the active program

Available: Always.

Range: rES Program reset;
run Program Start;
HoLd Program Hold;
cnt continue (read only).

When is necessary to edit a program, proceed as follows:

The instrument is showing the “standard display”.

1. Press the  button.
2. The upper display shows $U15$ while the lower display shows $Pr1$.
3. By  and  buttons select PrG .
4. Press the  button.
5. The upper display shows $\supset PrG$.
6. Press the  button.
7. The upper display shows $PAGE$ while the lower display shows the page number (1 or 2).
8. By  and  buttons select the desired page.
9. Press the  button and return to the $\supset PrG$ indication.
10. Press the  button until the group of the desired program is shown ($Pr1$, $Pr2$, $Pr3$ or $Pr4$).
11. Press the  button.

Note: In the following pages we use Program 1 as example.

$\supset Pr1$ Group - Program 1

[129] P1.F = Program 1 action at power up

Available: Always:

Range: nonE Program not used;
S.uP.d Start at power up with a first step in stand by;
S.uP.S Start at power up;
u.diG Start at RUN command detection only;
U.dG.d Start at RUN command detection with a first step in stand by.

[130] P1.u - Engineering units of the soaks

Available: When [129] P1.F is different from nonE.

Range: hh.nn Hours and minutes;
nn.SS= Minutes and seconds.

Note: During program execution, this parameter can not be changed.

[131] P1.E - Instrument behaviour at End of program 1 execution

Available: When [129] P1.F is different from nonE.

Range: cnt Continue (the instrument uses the set point of the last soak until a reset command is detected);
SPAt Go to the set point selected by [81] A.SP parameter;
St.bY Go in stand by mode.

- Notes:**
1. Setting [131] P1.E = cnt at program end the instrument uses the set point of the last soak. When a reset command is detected it will go to the set point selected by [81] A.SP parameter.
 2. Setting [131] P1.E = SPAt at program end the instrument goes to the set point selected by [81] A.SP parameter. The transfer will be a step transfer or a ramp according to the [84] SP.u (maximum rate of rise for positive set point change) and [85] SP.d (maximum rate of rise for negative set point change).
 3. Setting [131] P1.E = St.by at program end the instrument goes immediately in Stand-by mode (control outputs go to OFF and the instrument operate as an indicator).

[132] P1.nE - Execution number

Available: When [129] P1.F is different from nonE.

Range: 1 to 99 execution;
inF Indefinitely.

Note: Setting [132] P1.nE = inF the program execution will be repeated until a reset command is detected.

[133] P1.Et - Time of the End program indication

Available: When [129] P1.F is different from nonE.

Range: oFF Function not used;
00.01... 99.59 minutes and seconds;
inF Indefinitely ON.

Note: Setting [133] P1.Et = inF the end program indication goes OFF only when a reset command or a new RUN command is detected.

[134] P1.S1 - Set point of the first soak

Available: When [129] P1.F is different from nonE or [129] P1.F is different from S.uP.d.

Range: From [75] SPLL to [76] SPHL.

[135] P1.G1 - Gradient of the first ramp

Available: When [129] P1.F is different from *nonE* or [129] P1.F is different from S.uP.d.

Range: 0.1... 999.9 engineering units per minute; inF Step transfer.

[136] P1.t1 - Time of the first soak

Available: When [129] P1.F is different from *nonE*.

Range: 0.00... 99.59 Time units.

Note: Setting a time equal to zero, the instrument uses the wait band before to go to the next step.

[137] P1.b1 - Wait band of the first soak

Available: When [129] P1.F is different from *nonE* or [129] P1.F is different from S.uP.d.

Range: OFF... 9999 engineering units.

Note: The wait band suspends the time counting when the measured value goes out of the defined band (guaranteed soak).

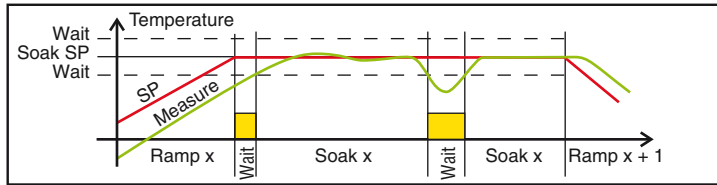

[138] P1.E1 - Events of the first group

Available: When [129] Pr.F is different from *nonE* or [129] Pr.F is different from S.UP.d.

Range: 00.00... 11.11 where:

- 0 event OFF;
- 1 event ON.

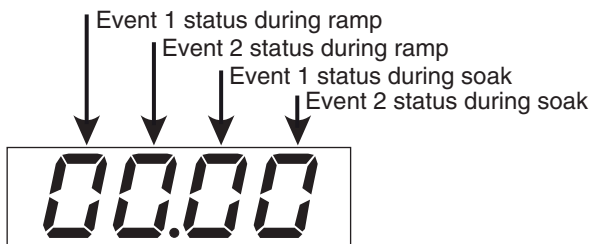

Display	Ramp		Soak	
	Event 1	Event 2	Event 1	Event 2
0000	off	off	off	off
1000	on	off	off	off
0100	off	on	off	off
1100	on	on	off	off
0010	off	off	on	off
1010	on	off	on	off
0110	off	on	on	off
1110	on	on	on	off
0001	off	off	off	on
1001	on	off	off	on
0101	off	on	off	on
1101	on	on	off	on
0011	off	off	on	on
1011	on	off	on	on
0111	off	on	on	on
1111	on	on	on	on

[139] P1.S2 - Set point of the second soak

Available: When [129] P1.F is different from *nonE*

Range: From [75] SPLL to [76] SPHL; oFF Program end.

Note: It is not necessary to configure all steps.

Using, for example, 2 groups only, it is sufficient to set the set point of the third group equal to OFF.

The instrument will mask all the following parameters of the program in editing.

[140] P1.G2 - Gradient of the second ramp

Available: When [129] P1.F is different from *nonE* and [139] P1.S2 is different from oFF.

Range: 0.1... 999.9 engineering units per minute; inF Step transfer.

[141] P1.t2 - Time of the second soak

Available: When [129] P1.F is different from *nonE* and [139] P1.S2 is different from oFF.

Range: 0.00... 99.59 time units.

Note: Setting a time equal to zero, the instrument uses the wait band before to go to the next step.

[142] P1.b2 - Wait band of the second soak

Available: When [129] P1.F is different from *nonE* and [139] P1.S2 is different from oFF.

Range: OFF... 9999 engineering units.

Note: For more details see [137]P1.b1 parameter.

[143] P1.E2 - Events of the second group

Available: When [129] P1.F is different from *nonE* and [139] P1.S2 is different from oFF.

Range: 00.00... 11.11 where:

- 0 Event OFF;
- 1 Event ON.

Note: For more details see [138]P1.E1 parameter.

[144] P1.S3 - Set point of the third soak

Available: When [129] P1.F is different from *nonE* and [139] P1.S2 is different from oFF.

Range: from [75] SPLL to [76] SPHL; oFF Program end.

Note: For more details see [139]P1.S2 parameter.

[145] P1.G3 - Gradient of the third ramp

Available: When [129] P1.F is different from *nonE*, [139] P1.S2 is different from oFF and [144] P1.S3 is different from oFF.

Range: 0.1... 999.9 engineering units per minute; inF Step transfer.

[146] P1.t3 - Time of the third soak

Available: When [129] P1.F is different from *nonE*, [139] P1.S2 is different from oFF and [144] P1.S3 is different from oFF.

Range: 0.00... 99.59 time units.

Note: Setting a time equal to zero, the instrument uses the wait band before to go to the next step.

[147] P1.b3 - Wait band of the third soak

Available: When [129] P1.F is different from *nonE*, [134] P1.S2 is different from oFF and [139] P1.S3 is different from oFF.

Range: OFF... 9999 engineering units.

Note: For more details see [137]P1.b1 parameter.

[148] P1.E3 - Events of the third group

Available: When [129] P1.F is different from $nOnE$,
[139] P1.S2 is different from oFF and
[144] P1.S3 is different from oFF .

Range: 00.00... 11.11 where:

0 Event OFF;
1 Event ON.

Note: For more details see [138]P1.E1 parameter.

[149] P1.S4 - Set point of the fourth soak

Available: When [129] P1.F is different from $nOnE$,
[139] P1.S2 is different from oFF and
[144] P1.S3 is different from oFF .

Range: From [75] SPLL to [76] SPHL;
oFF Program end.

Note: For more details see [139]P1.S2 parameter.

[150] P1.G4 - Gradient of the fourth ramp

Available: When [129] P1.F is different from $nOnE$,
[139] P1.S2 is different from oFF ,
[144] P1.S3 is different from oFF and
[149] P1.S4 is different from oFF

Range: 0.1... 999.9 engineering units per minute;
inF Step transfer.

[151] P1.t4 - Time of the fourth soak

Available: When [129] P1.F is different from $nOnE$,
[139] P1.S2 is different from oFF ,
[144] P1.S3 is different from oFF and
[149] P1.S4 is different from oFF .

Range: 0.00... 99.59 time units.

[152] P1.b4 - Wait band of the fourth soak

Available: When [129] P1.F is different from $nOnE$,
[139] P1.S2 is different from oFF ,
[144] P1.S3 is different from oFF and
[149] P1.S4 is different from oFF .

Range: From OFF to 9999 engineering units.

Note: For more details see [137] P1.b1 parameter.

[153] P1.E4 - Event of the fourth segment

Available: When [129] P1.F is different from $nOnE$,
[139] P1.S2 is different from oFF ,
[144] P1.S3 is different from oFF and
[149] P1.S4 is different from oFF .

Range: 00.00... 11.11 where:

0 Event OFF;
1 Event ON.

Note: For more details see [138] P1.E1 parameter.

[154] P1.S5 - Set point of the fifth soak

Available: When [129] P1.F is different from $nOnE$,
[139] P1.S2 is different from oFF ,
[144] P1.S3 is different from oFF and
[149] P1.S4 is different from oFF .

Range: From [75] SPLL to [76] SPHL;
oFF Program end.

Note: For more details see [139] P1.S2 parameter.

[155] P1.G5 - Gradient of the fifth ramp

Available: When [129] P1.F is different from $nOnE$,
[139] P1.S2 is different from oFF ,
[144] P1.S3 is different from oFF ,
[149] P1.S4 is different from oFF and
[154] P1.S5 is different from oFF .

Range: 0.1... 999.9 engineering units per minute;
inF Step transfer.

[156] P1.t5 - Time of the fifth soak

Available: When [129] P1.F is different from $nOnE$,
[139] P1.S2 is different from oFF ,
[144] P1.S3 is different from oFF ,
[149] P1.S4 is different from oFF and
[154] P1.S5 is different from oFF .

Range: 0.00... 99.59 time units.

[157] P1.b5 - Wait band of the fifth soak

Available: When [129] P1.F is different from $nOnE$,
[139] P1.S2 is different from oFF ,
[144] P1.S3 is different from oFF ,
[149] P1.S4 is different from oFF and
[154] P1.S5 is different from oFF .

Range: From OFF to 9999 engineering units.

Note: For more details see [137] P1.b1 parameter.

[158] P1.E5 - Event of the fifth segment

Available: When [129] P1.F is different from $nOnE$,
[139] P1.S2 is different from oFF ,
[144] P1.S3 is different from oFF ,
[149] P1.S4 is different from oFF and
[154] P1.S5 is different from oFF .

Range: 00.00... 11.11 where:

0 Event OFF;
1 Event ON.

Note: For more details see [138]P1.E1 parameter.

[159] P1.S6 - Set point of the sixth soak

Available: When [129] P1.F is different from $nOnE$,
[139] P1.S2 is different from oFF ,
[144] P1.S3 is different from oFF ,
[149] P1.S4 is different from oFF and
[154] P1.S5 is different from oFF .

Range: From [75] SPLL to [76] SPHL;
oFF Program end.

Note: For more details see [139]P1.S2 parameter.

[160] P1.G6 - Gradient of the sixth ramp

Available: When [129] P1.F is different from $nOnE$,
[139] P1.S2 is different from oFF ,
[144] P1.S3 is different from oFF ,
[149] P1.S4 is different from oFF ,
[154] P1.S5 is different from oFF and
[159] P1.S6 is different from oFF .

Range: 0.1... 999.9 engineering units per minute;
inF Step transfer.

[161] P1.t6 - Time of the sixth soak

Available: When [129] P1.F is different from $nOnE$,
[139] P1.S2 is different from oFF ,
[144] P1.S3 is different from oFF ,
[149] P1.S4 is different from oFF ,
[154] P1.S5 is different from oFF and
[159] P1.S6 is different from oFF .

Range: 0.00... 99.59 time units.

[162] P1.b6 - Wait band of the sixth soak

Available: When [129] P1.F is different from $nOnE$,
[139] P1.S2 is different from oFF ,
[144] P1.S3 is different from oFF ,
[149] P1.S4 is different from oFF ,
[154] P1.S5 is different from oFF and
[159] P1.S6 is different from oFF .

Range: From OFF to 9999 engineering units.

Note: For more details see [137] P1.b1 parameter.

[163] P1.E6 - Event of the sixth segment

Available: When [129] P1.F is different from *nonE*,
[139] P1.S2 is different from *oFF*,
[144] P1.S3 is different from *oFF*,
[149] P1.S4 is different from *oFF*,
[154] P1.S5 is different from *oFF* and
[159] P1.S6 is different from *oFF*.

Range: 00.00... 11.11 where:
0 Event OFF;
1 Event ON.

Note: For more details see [138]P1.E1 parameter.

[164] P1.c2 - Program 1 continue on program 2

Available: When [129] P1.F is different from *nonE*.
Range: no Program 1 is ended
YES Program 1 will continue on program 2

Pr2 Group - Program 2

The same descriptions made for Pr1 (Program 1) parameters can be applied to the Pr2 parameters with the exception of the prefix that changes from P1.xx to P2.xx (Program 2).

For more details see Pr1 group.

Pr3 Group - Program 3

The same descriptions made for Pr1 (Program 1) parameters can be applied to the Pr3 parameters with the exception of the prefix that changes from P1.xx to P3.xx (Program 3).

For more details see Pr1 group.

Pr4 Group - Program 4

The same descriptions made for Pr1 (program 1) can be applied to the Pr4with the exception of:

- a) The prefix that changes from P1.xx to P4.xx (Program 4).
- b) The last program of each page could NOT continue on the next program (because we do not have a fifth program).

For more details see Pr1 group.

Pr5 Group - Program 5

The same descriptions made for Pr1 (Program 1) parameters can be applied to the Pr5 parameters with the exception of the prefix that changes from P1.xx to P5.xx (Program 5).

For more details see Pr1 group.

Pr6 Group - Program 6

The same descriptions made for Pr1 (Program 1) parameters can be applied to the Pr6 parameters with the exception of the prefix that changes from P1.xx to P6.xx (Program 6).

For more details see Pr1 group.

Pr7 Group - Program 7

The same descriptions made for Pr1 (Program 1) parameters can be applied to the Pr7 parameters with the exception of the prefix that changes from P1.xx to P7.xx (Program 7).

For more details see Pr1 group.

Pr8 Group - Program 8

The same descriptions made for Pr1 (program 1) can be applied to the Pr8 with the exception of:

- a) The prefix that changes from P1.xx to P8.xx (Program 8).
- b) The last program of each page could NOT continue on the next program (because we do not have a ninth program).

For more details see Pr1 group.

8.2 How to exit from program editing

When you want to come back to the “standard display” push the  button for more than 5 seconds.

Note: The parameter modification of the Operator level is subject to a time out. If no button is pressed for more than 10 seconds, the instrument goes back to the “standard display” and the new value of the last selected parameter will be lost.

8.3 How to Link two (or more) programs

Program linking can give you more advantages:

- A) When you need a program with more than 12 segments you can link the selected program with the next one. In this way it is possible to obtain “profile” with 24, 36 or 48 steps.
- B) Another reason is the possibility to use different time bases in the same “profile”.
- C) When you link more programs you can start the execution from the desired one.

E.g.: To link Pr1 (pre-heat with 1 execution only), Pr2 (first part of a heat treatment with 4 executions) and Pr3 (second part of the heat treatment with 2 executions), you can:

- I) RUN program 1; the instrument performs in sequence Pr1, Pr2 and Pr3; One time only.
- II) RUN program 2; the instrument performs Pr2 and Pr3 Pr4 times before ending.
- III) RUN program 3; the instrument will perform Pr3 2 times before ending.

In a realistic application example the pre-heat phase is important at power up only (aimed to reduces the thermal stress of the oven during start up). For this reason you can program Pr1 for start at power up (at power up the instrument will perform all phases) and then all next treatments of the day will be made running Pr2 (with 1 execution only).

In the following example we create a profile using a Pre-heat of 4 segment and a treatment phase using 18 segments Now we can built the profile proceeding as follows:

1. Select Page 1;
2. Select the Program 1;
3. Set the desired RUN type (P1.F = S.UP.S);
4. Set the first time base (P1.u = mm.SS);
5. Set the desired program end (e.g. P1.E = A.SP);
6. Set the desired execution number (P1 nE = 1);
7. Set the first 2 groups of parameters (2 ramps and 2 soaks). Now, the pre-heat phase is finished.
8. End this phase by setting the next parameter (P1.S3) equal to OFF (P1.S3 = OFF)

The instrument will mask all parameters of the Pr1 after P1.S3 exception made for the parameter P1.c2 (program 1 continue on program 2).

9. Set P1.C2 equal to YES.

10. Press the  button until Pr2 is shown.

11. Enter in Pr2.

12. Set the specific RUN type (P2.F = U.diG).

13. Set the time base (P2.u = hh.nn).

14. Set the program end (P2.E = A.SP).

15. Set the execution number (P2.nE = 1).

16. Set the all segments (6 ramps and 6 soaks).

17. Set P2.C3 equal to YES (continue on Pr3).

18. Press the  button until Pr3 is shown.

19. Enter in Pr3;

20. Set the specific RUN type (e.g. P3.F = U.diG).

21. Set the time base (P3.u = hh.nn).

22. Set the desired program end (P3.E = A.SP).

23. Set the execution number (P3.nE = 1).

24. Set all necessary segments (3 ramps and 3 soaks).

Now, the treatment phases is finished.

25. End this phase by setting the next parameter (P3.S4) equal to OFF (P3.S4 = OFF).

26. Set P3.C4 equal to no (do NOT continue on Pr4).

27. Set USrb (function of the  button) equal to P.run

Now you can set Page = 1, set Pr.n = 1 (Program 1), turn off the ovens and load it with the first set of objects to be treated during the next day.

The next day you can turn on the oven; the instrument will perform the pre-heat and the complete treatment of the material.

At the end of the treatment the oven operates according to P3.E setting (in our example it maintains the temperature set by SP).

Remove the material already treated.

Load a new set.

Set Pr.n =2 (Program 2)

Push the  button.

The instrument will perform only the complete treatment (Pr2 followed by Pr3) of the material.

8.4 How to Run a program

The Run command can be sent to the instrument by:

- [128] Pr.St parameter (= run);
-  button (when [88] U.Srb = P.run or P.r.H.r);
- Digital input (when [10] diF1 = 6, 9, 10 or [11] diF2 = 6,9,10).
- By serial link,

Note: The decimal point of the LSD of the lower display is used to show the programmer status independently from the displayed value selected by [121] diSP (Display management).

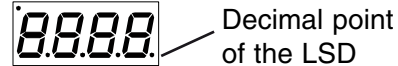

The relation between the programmer status and the LED are the following:

- Program in RUN - the LED is ON;
- Program in Hold - The LED is flashing fast;
- Program in wait - The LED is flashing slow;
- Program in end or reset - The LED is OFF.

8.5 How to Hold a program

This function temporarily stops a running program by a manual action.

When the program is in hold, the set point updating and time count are stopped and the instrument operates as controller with fixed set point.

The HOLD mode may be activated:

- Setting [128] Pr.St parameter (= HoLd);
- A short pressure of the  button (when USrb = P.r.H.r);
- By digital input (when [10] diF1 = 8, 9 or [11] diF2 = 8, 9);
- By serial link.

When a program is in Hold, the decimal point of the LSD of the lower display flashes fast.

When the lower display is programmed to show informations related with program running (diSP = Pr.tu, Pr.td, P.t.td or P.t.tu) the lower display will flash at the same "speed" of the decimal point of the LSD.

One of the actions described for Hold activation can be used to come back to the RUN mode.

8.5.1 Differences between HOLD and WAIT mode

Both functions temporarily stop a running program but the Hold function requires a manual action (when you want to start and to stop it) while the Wait function is an automatic function (and it can be start and stop automatically only).

The WAIT mode starts automatically when, during a soak, the measured value is out of the wait band programmed for it and it will be stopped when the measured value reaches the wait band.

When a program is in Hold, the decimal point of the LSD of the lower display flashes fast and the [128] Pr.St parameter shows "HoLd".

When a program is in Wait, the decimal point of the LSD of the lower display will flash slow and the [128] Pr.St parameter shows "run".

8.6 How to Abort/Reset a running program

To permanently stop a running profile, it is sufficient to:

- Set [128] Pr.St parameter = rES;
- Press the  button for more than 5 seconds (when [88] U.Srb = P.r.H.r);
- By digital input (when [10] diF1 = 7, 10 or [11] diF2 = 7, 10);
- By serial link.

Note: When a program is aborted, the instrument operates as follows:

- If the “Program end” (Px.E) has been programmed as A.SP or cnt, the instrument returns to Automatic mode using the SP selected by A.SP.
- If the “Program end” (Px.E) has been programmed as St.bY, the instrument returns to Stand by mode.

8.6.1 Manual mode during program execution

The manual mode HOLD the program execution.

When the instrument returns to the Auto mode, the program execution will automatically continue.

8.6.2 Stand-by mode during program execution

The Stand-by mode Aborts the program execution.

8.6.3 Program behaviour when a power off occurs during program execution

During program execution the instrument stores the segment currently in use and, by a 1 minute interval, it stores also the elapsed time of the soaks and the remaining repetition(s).

If a power down occurs during program execution, at the next power up the instrument is able to continue the program execution and make all remaining repetitions starting from the segment in progress at power down and, if the segment was a soak, it is also capable to restart from the soak time minus the elapsed time memorized.

In order to obtain this features, the “[95] dSPu - (Status of the instrument at power up”) parameter must be set to “AS.Pr”.

If the “[95] dSPu” parameter is different from “AS.Pr” The memorization function is inhibited.

9 MESSAGES

9.1 Out of range Indications

The upper display shows the OVER-RANGE and UNDER-RANGE conditions with the following indications:

Over-range



Under-range



The sensor break is signalled as an out of range:

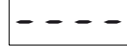

Note: When an over-range or an under-range is detected, the alarms operate as in presence of the maximum or the minimum measurable value respectively.

To check the out of span Error condition, proceed as follows:

1. Check the input signal source and the connecting line;
2. Make sure that the input signal is in accordance with the instrument configuration.
Otherwise, modify the input configuration (see section 4);
3. If no error is detected, send the instrument to your supplier to be checked.

9.2 List of possible errors

<i>ErALt</i>	Fast Auto-tune cannot start. The measure value is too close to the set point. Push the  button in order to delete the error message.
<i>oULd</i>	Overload on output 4. The message shows that a short circuit is present on Out 4 when it is used as output or transmitter power supply. When the short circuit disappears the output restarts to operate.
<i>noALt</i>	Auto-tune not finished within 12 hours.
<i>ErEP</i>	Possible problem in the instrument memory. The message should automatically disappear, if the error persists, send the instrument to your supplier.
<i>ronE</i>	Possible problem of the firmware memory. If this error is detected, send the instrument to your supplier.
<i>Errt</i>	Possible problem of the calibration memory. If this error is detected, send the instrument to your supplier.

10 GENERAL NOTES

10.1 Proper use

Every possible use not described in this manual must be considered as a improper use.

This instrument is in compliance with EN 61010-1 “Safety requirements for electrical equipment for measurement, control and laboratory use”; for this reason it could not be used as a safety equipment.

Whenever a failure or a malfunction of the control device may cause dangerous situations for persons, thing or animals, please remember that the plant has to be equipped with additional safety devices.

Ascon Tecnologic S.r.l. and its legal representatives do not assume any responsibility for any damage to people, things or animals deriving from violation, wrong or improper use or in any case not in compliance with the instrument’s features.

10.2 Warranty

This product is under warranty against manufacturing defects or faulty materials that are found within 18 months from delivery date. The warranty is limited to repairs or to the replacement of the instrument.

The tampering of the instrument or an improper use of the product will bring about the immediate withdrawal of the warranty’s effects.

In the event of a faulty instrument, either within the period of warranty, or further to its expiry, please contact our sales department to obtain authorisation for sending the instrument to our company.

The faulty product must be shipped to Ascon Tecnologic with a detailed description of the faults found, without any fees or charge for Ascon Tecnologic, except in the event of alternative agreements.

10.3 Maintenance

This instrument does not require periodical recalibration and it have no consumable parts so that no particular maintenance is required.

Sometimes it is advisable to clean the instrument.

1. **SWITCH THE EQUIPMENT OFF**
(power supply, relay output, etc.).
2. Using a vacuum cleaner or a compressed air jet (max. 3 kg/cm²) remove all deposits of dust and dirt which may be present on the case and on the internal circuits being careful not to damage the electronic components.
3. To clean external plastic or rubber parts use only a cloth moistened with:
 - Ethyl Alcohol (pure or denatured) [C₂H₅OH] or
 - Isopropyl Alcohol (pure or denatured) [(CH₃)₂CHOH] or
 - Water (H₂O).
4. Make sure that there are no loose terminals.
5. Before turning ON the instrument make sure it is perfectly dry.
6. Apply the power supply to the instrument.

10.4 Disposal

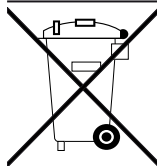

The appliance (or the product) must be disposed of separately in compliance with the local standards in force on waste disposal.

10.5 Accessories

The instrument has a lateral socket into which a special tool can be inserted. This tool, named A01, allows:





- To store a complete instrument configuration and to use it for other instruments.
- To transfer a complete instrument configuration to a PC or from a PC to an instrument
- To transfer from a PC to an instrument a complete instrument configuration
- To transfer a configuration from an A01 to another one.
- To test serial interface of the instruments and to help the OEM during machine start up.

Note: When the instrument is powered by the A01 key, the outputs are NOT supplied and the instrument can show the *ouLd* (Out 4 Overload) indication.

Appendix A

³inP GROUP - Main and auxiliary input configuration

no.	Param.	Description	Dec. Point	Values	Default
1	SEnS	Sensor selection (according to the HW)			
		Model C	0	J TC J (0... 1000°C/32... 1832°F); crAL TC K (0... 1370°C/32... 2498°F); S TC S (0... 1760°C/32... 3200°F); r TC R (0... 1760°C/32... 3200°F); t TC T (0... 400°C/32... 752°F); n TC N (0... 1000°C/32... 1832°F); ir.J Exergen IRS J (0... 1000°C/32... 1832°F); ir.cA Exergen IRS K (0... 1370°C/32... 2498°F); Pt1 RTD Pt 100 (-200... 850°C/-328... 1562°F); Pt10 RTD Pt 1000 (-200... 500°C/-328... 932°F); 0.60 0... 60 mV; 12.60 12... 60 mV; 0.20 0... 20 mA; 4.20 4... 20 mA; 0.5 0... 5 V; 1.5 1... 5 V; 0.10 0... 10 V; 2.10 2... 10 V.	J
		Model E	0	J TC J (0... 1000°C/32... 1832°F); crAL TC K (0... 1370°C/32... 2498°F); S TC S (0... 1760°C/32... 3200°F); r TC R (0... 1760°C/32... 3200°F); t TC T (0... 400°C/32... 752°F); n TC N (0... 1000°C/32... 1832°F); ir.J Exergen IRS J (0... 1000°C/32... 1832°F); ir.cA Exergen IRS K (0... 1370°C/32... 2498°F); Ptc PTC (-55... 150°C/-67... 302°F); ntc NTC (-50... 110°C/-58... 230°F); 0.60 0... 60 mV; 12.60 12... 60 mV; 0.20 0... 20 mA; 4.20 4... 20 mA; 0.5 0... 5 V; 1.5 1... 5 V; 0.10 0... 10 V; 2.10 2... 10 V.	J
2	dp	Decimal Point Position (linear inputs)	0	0... 3	
		Decimal Point Position (different than linear inputs)	0	0/1	0
3	SSc	Initial scale read-out for linear inputs	dp	-1999... 9999	0
4	FSc	Full Scale Readout for linear inputs	dp	-1999... 9999	1000
5	unit	Engineering unit		°C/°F	°C
6	Fil	Digital filter on the measured value	1	0 (= OFF)/0.1... 20.0 s	1.0
7	inE	Sensor error used to enable the safety output value		or Over range; ou Under range; our Over and under range.	our
8	oPE	Safety output value (% of the output)		-100... 100	0
9	IO4.F	I/O 4 function		on Output used as PWS for TX; out4 Output 4 (digital output 4); dG2c Digital input 2 driven by contact; dG2U Digital input 2 driven by voltage.	out4
10	diF1	Digital Input 1 function		oFF = Not used; 1 Alarm reset; 2 Alarm acknowledge (ACK); 3 Hold of the measured value; 4 Stand by mode; 5 Manual mode; 6 Program RUN; 7 Program Reset; 8 Program Hold; 9 Program Run/Hold; 10 Program Run/Reset; 11 Sequential SP selection; 12 SP1 - SP2 selection; 13 SP1... SP4 binary selection; 14 Digital inputs in parallel to  and  keys.	oFF
11	diF2	Digital Input 2 function			oFF
12	di.A	Digital Inputs Action (DI2 only if configured)		0 DI1 direct action, DI2 direct action; 1 DI1 reverse action, DI2 direct action; 2 DI1 direct action, DI2 reverse action; 3 DI1 reverse action, DI2 reverse action.	0

Out group

no.	Param.	Description	Dec. Point	Values	Default
13	o1t	Output 1 type (when Out 1 is an analogue output)		0-20 0... 20 mA; 4-20 4... 20 mA; 0-10 0... 10 V; 2-10 2... 10 V.	0-20
14	o1F	Out 1 function (when Out 1 is a linear output)	0	NonE Output not used; H.rEG Heating output; c.rEG Cooling output; r.inP Measure retransmission; r.Err Error (sp - PV) retransmission; r.SP Set point retransmission ; r.SEr Serial value retransmission.	H.reG
		Out 1 function (when Out1 is a digital output)	0	NonE Output not used; H.rEG Heating output; c.rEG Cooling output; AL Alarm output; P.End Program end indicator; P.HLd Program hold indicator; P.uit Program wait indicator; P.run Program run indicator; P.Et1 Program Event 1 ; P.Et2 Program Event 2; or.bo Out-of-range or Burnout indicator; P.FAL Power failure indicator; bo.PF Out-of-range, Burnout and Power failure indicator; St.bY Stand by status indicator; diF.1 Out1 repeats the digital input 1 status; diF.2 Out1 repeats the digital input 2 status; on Out1 always ON; riSP Inspection request.	
15	Ao1L	Initial scale value of the analog retransmission	dP	-1999 ... Ao1H	-1999
16	Ao1H	Full scale value of the analog retransmission	dP	Ao1L ... 9999	9999
17	o1AL	Alarms linked up with the out 1	0	0... 63: +1 Alarm 1; +2 Alarm 2; +4 Alarm 3; +8 Loop break alarm; +16 Sensor Break; +32 Overload on output 4.	AL1
18	o1Ac	Out 1 action	0	dir Direct action; rEU Reverse action; dir.r Direct with reversed LED; ReU.r Reverse with reversed LED.	dir
19	o2F	Out 2 function	0	NonE Output not used; H.rEG Heating output; c.rEG Cooling output; AL Alarm output; P.End Program end indicator; P.HLd Program hold indicator; P.uit Program wait indicator; P.run Program run indicator; P.Et1 Program Event 1 ; P.Et2 Program Event 2; or.bo Out-of-range or Burnout indicator; P.FAL Power failure indicator; bo.PF Out-of-range, Burnout and Power failure indicator; St.bY Stand by status indicator; diF.1 Out2 repeats the digital input 1 status; diF.2 Out2 repeats the digital input 2 status; on Out2 always ON; riSP Inspection request.	AL
20	o2AL	Alarms linked up with the out 2	0	0... 63: +1 Alarm 1; +2 Alarm 2; +4 Alarm 3; +8 Loop break alarm; +16 Sensor Break; +32 Overload on output 4.	AL1
21	o2Ac	Out 2 action	0	dir Direct action; rEU Reverse action; dir.r Direct with reversed LED; ReU.r Reverse with reversed LED.	dir

no.	Param.	Description	Dec. Point	Values	Default
22	o3F	Out 3 function	0	NonE Output not used; H.rEG Heating output; c.rEG Cooling output; AL Alarm output; P.End Program end indicator; P.HLd Program hold indicator; P.uit Program wait indicator; P.run Program run indicator; P.Et1 Program Event 1; P.Et2 Program Event 2; or.bo Out-of-range or Burnout indicator; P.FAL Power failure indicator; bo.PF Out-of-range, Burnout and Power failure indicator; St.bY Stand by status indicator; diF.1 Out3 repeats the digital input 1 status; diF.2 Out3 repeats the digital input 2 status; on Out3 always ON; riSP Inspection request.	AL
23	o3AL	Alarms linked up with the out 3	0	0... 63: +1 Alarm 1; +2 Alarm 2; +4 Alarm 3; +8 Loop break alarm; +16 Sensor Break; +32 Overload on output 4.	AL2
24	o3Ac	Out 3 action	0	dir Direct action; rEU Reverse action; dir.r Direct with reversed LED; ReU.r Reverse with reversed LED.	dir
25	o4F	Out 4 function	0	NonE Output not used; H.rEG Heating output; c.rEG Cooling output; AL Alarm output; P.End Program end indicator; P.HLd Program hold indicator; P.uit Program wait indicator; P.run Program run indicator; P.Et1 Program Event 1; P.Et2 Program Event 2; or.bo Out-of-range or Burnout indicator; P.FAL Power failure indicator; bo.PF Out-of-range, Burnout and Power failure indicator; St.bY Stand by status indicator.	AL
26	o4AL	Alarms linked up with the out 4	0	0... 63: +1 Alarm 1; +2 Alarm 2; +4 Alarm 3; +8 Loop break alarm; +16 Sensor Break; +32 Overload on output 4.	AL1 + L2
27	o4Ac	Out 4 action	0	dir Direct action; rEU Reverse action; dir.r Direct with reversed LED; ReU.r Reverse with reversed LED.	dir

² AL1 group

no.	Param.	Description	Dec. Point	Values	Default
28	AL1t	Alarm 1 type	0	nonE Alarm not used; LoAb Absolute low alarm; HiAb Absolute high alarm; LHAo Absolute band alarm, alarm ON outside the band; LHAi Absolute band alarm, alarm ON inside the band; SE.br Sensor Break; LodE Deviation low alarm (relative); HidE Deviation high alarm (relative); LHdo Relative band alarm, alarm ON outside the band; LHdi Relative band alarm, alarm ON inside the band.	HiAb
29	Ab1	Alarm 1 function	0	0... 15: +1 Not active at power up; +2 Latched alarm (manual reset); +4 Acknowledgeable alarm; +8 Relative alarm not active at set point change.	0

no.	Param.	Description	Dec. Point	Values	Default
30	AL1L	- For High and low alarms, it is the low limit of the AL1 threshold; - For band alarm, it is low alarm threshold	dp	From -1999 to AL1H (E.U.)	-1999
31	AL1H	- For High and low alarms, it is the high limit of the AL1 threshold; - For band alarm, it is high alarm threshold	dp	From AL1L to 9999 (E.U.)	9999
32	AL1	AL1 threshold	dp	From AL1L to AL1H (E.U.)	0
33	HAL1	AL1 hysteresis	dp	1... 9999 (E.U.)	1
34	AL1d	AL1 delay	0	From 0 (oFF) to 9999 (s)	oFF
35	AL1o	Alarm 1 enabling during Stand-by mode and out of range conditions	0	0Alarm 1 disabled during Stand by and out of range; 1Alarm 1 enabled in stand by mode; 2Alarm 1 enabled in out of range condition; 3Alarm 1 enabled in stand by mode and in overrange condition.	0

² AL2 group

no.	Param.	Description	Dec. Point	Values	Default
36	AL2t	Alarm 2 type	0	nonE Alarm not used; LoAb Absolute low alarm; HiAb Absolute high alarm; LHAo Absolute band alarm, alarm ON outside the band; LHAi Absolute band alarm, alarm ON inside the band; SE.br Sensor Break; LodE Deviation low alarm (relative); HidE Deviation high alarm (relative); LHdo Relative band alarm, alarm ON outside the band; LHdi Relative band alarm, alarm ON inside the band.	Loab
37	Ab2	Alarm 2 function	0	0... 15: +1 Not active at power up; +2 Latched alarm (manual reset); +4 Acknowledgeable alarm; +8 Relative alarm not active at set point change.	0
38	AL2L	- For High and low alarms, it is the low limit of the AL2 threshold; - For band alarm, it is low alarm threshold	dp	From -1999 to AL2H (E.U.)	-1999
39	AL2H	- For High and low alarms, it is the high limit of the AL2 threshold; - For band alarm, it is high alarm threshold	dp	From AL2L to 9999 (E.U.)	9999
40	AL2	AL2 threshold	dp	From AL2L to AL2H (E.U.)	0
41	HAL2	AL2 hysteresis	dp	1... 9999 (E.U.)	1
42	AL2d	AL2 delay	0	From 0 (oFF) to 9999 (s)	oFF
43	AL2o	Alarm 2 enabling during Stand-by mode and out of range conditions	0	0Alarm 2 disabled during Stand by and out of range; 1Alarm 2 enabled in stand by mode; 2Alarm 3 enabled in out of range condition; 3Alarm 3 enabled in stand by mode and in overrange condition.	0

² AL3 group

no.	Param.	Description	Dec. Point	Values	Default
44	AL3t	Alarm 3 type	0	nonE Alarm not used; LoAb Absolute low alarm; HiAb Absolute high alarm; LHAo Absolute band alarm, alarm ON outside the band; LHAi Absolute band alarm, alarm ON inside the band; SE.br Sensor Break; LodE Deviation low alarm (relative); HidE Deviation high alarm (relative); LHdo Relative band alarm, alarm ON outside the band; LHdi Relative band alarm, alarm ON inside the band.	nonE
45	Ab3	Alarm 3 function	0	0... 15: +1 Not active at power up; +2 Latched alarm (manual reset); +4 Acknowledgeable alarm; +8 Relative alarm not active at set point change.	0

no.	Param.	Description	Dec. Point	Values	Default
46	AL3L	- For High and low alarms, it is the low limit of the AL3 threshold; - For band alarm, it is low alarm threshold	dp	From -1999 to AL3H (E.U.)	-1999
47	AL3H	- For High and low alarms, it is the high limit of the AL3 threshold; - For band alarm, it is high alarm threshold	dp	From AL3L to 9999 (E.U.)	9999
48	AL3	AL3 threshold	dp	From AL3L to AL3H (E.U.)	0
49	HAL3	AL3 hysteresis	dp	1... 9999 (E.U.)	1
50	AL3d	AL3 delay	0	From 0 (oFF) to 9999 (s)	oFF
51	AL3o	Alarm 3 enabling during Stand-by mode and out of range conditions	0	0Alarm 3 disabled during Stand by and out of range; 1Alarm 3 enabled in stand by mode; 2Alarm 3 enabled in out of range condition; 3Alarm 3 enabled in stand by mode and in overrange condition.	0

² LBA group - Loop Break Alarm Parameters

no.	Param.	Description	Dec. Point	Values	Default
52	LbAt	LBA time	0	From 0 (oFF) to 9999 (s)	oFF
53	LbSt	Delta measure used by LBA during Soft start	dP	From 0 (oFF) to 9999 (E.U.)	10
54	LbAS	Delta measure used by LBA	dP	1...9999 (E.U.)	20
55	LbcA	Condition for LBA enabling	0	uP Active when Pout = 100%; dn Active when Pout = -100%; both Active in both cases.	both

² rEG group - Control Parameters

no.	Param.	Description	Dec. Point	Values	Default
56	cont	Control type	0	Pid PID (heat and/or); On.FA ON/OFF asymmetric hysteresis; On.FS ON/OFF symmetric hysteresis; nr Heat/Cool ON/OFF control with neutral zone; 3Pt Servomotor control (available only when Output 2 and Output 3 have been ordered as "M").	Pid
57	Auto	Autotuning selection	0	-4 Oscillating auto-tune with automatic restart at power up and after set point change; -3 Oscillating auto-tune with manual start; -2 Oscillating -tune with automatic start at the first power up only; -1 Oscillating auto-tune with automatic restart at every power up; 0 Not used; 1 Fast auto tuning with automatic restart at every power up; 2 Fast auto-tune with automatic start the first power up only; 3 FAST auto-tune with manual start; 4 FAST auto-tune with automatic restart at power up and after set point change; 5 Evo-tune with automatic restart at every power up; 6 Evo-tune with automatic start the first power up only; 7 Evo-tune with manual start; 8 Evo-tune with automatic restart at power up and after a set point change.	7
58	tunE	Manual start of the Autotuning	0	oFF = Not active; on = Active.	oFF
59	HSEt	Hysteresis of the ON/OFF control	dP	0... 9999 (E.U.)	1
60	Pb	Proportional band	dP	1... 9999 (E.U.)	50
61	ti	Integral time	0	0 (oFF)/1... 9999 (s)/inF (integral time excluded)	200
62	td	Derivative time	0	0 (oFF)/1... 9999 (s)	50
63	Fuoc	Fuzzy overshoot control	2	0.00... 2.00	0.50
64	tcH	Heating output cycle time	1	0.1... 130.0 (s)	20.0
65	rcG	Power ratio between heating and cooling action	2	0.01... 99.99	1.00
66	tcc	Cooling output cycle time	1	0.1... 130.0 (s)	20.0
67	rS	Manual reset (Integral pre-load)	1	-100.0... +100.0 (%)	0.0
68	Str.t	Servomotor stroke time	0	5...1000 (s)	60
69	db.S	Servomotor dead band	0	0...100%	50
70	od	Delay at power up	2	From 0.00 (oFF) to 99.59 (hh.mm)	oFF

no.	Param.	Description	Dec. Point	Values	Default
71	St.P	Maximum power output used during soft start	0	-100... 100 (%)	0
72	SSt	Soft start time	2	- 0.00 (oFF); - 0.01... 7.59 (hh.mm); - inF (always ON).	oFF
73	SS.tH	Threshold for soft start disabling	dP	-1999... +9999 (E.U.)	9999

SP group - Set point parameters

no.	Param.	Description	Dec. Point	Values	Default
74	nSP	Number of used set points	0	1... 4	1
75	SPLL	Minimum set point value	dP	From -1999 to SPLH	-1999
76	SPLH	Maximum set point value	dP	From SPLL to 9999	9999
77	SP	Set point 1	dP	From SPLL to SPLH	0
78	SP 2	Set point 2	dP	From SPLL to SPLH	0
79	SP 3	Set point 3	dP	From SPLL to SPLH	0
80	SP 4	Set point 4	dP	From SPLL to SPLH	0
81	A.SP	Selection of the active set point	0	From 1 (SP 1) to nSP	1
82	SP.rt	Remote set point type	0	RSP The value coming from serial link is used as remote set point; trin The value will be added to the local set point selected by A.SP and the sum becomes the operative set point; PErc = The value will be scaled on the input range and this value will be used as remote SP.	trin
83	SPLr	Local/remote set point selection	0	Loc Local; rEn = Remote.	Loc
84	SP.u	Rate of rise for POSITIVE set point change (ramp UP)	2	0.01... 99.99 Eng. units per minute/inF (ramp disabeld)	inF
85	SP.d	Rate of rise for NEGATIVE set point change (ramp DOWN)	2	0.01... 99.99 Eng. units per minute/inF (ramp disabeld)	inF

PAn group - Operator HMI parameters

no.	Param.	Description	Dec. Point	Values	Default
86	PAS2	Level 2 password (limited access level)	0	- oFF (Level 2 not protected by password) - 1... 200	20
87	PAS3	Level 3 password (complete configuration level)	0	3... 200	30
88	uSrb	 button function during RUN TIME		nonE No function; tunE Auto-tune/self-tune enabling. A single press (longer than 1 second) starts the auto-tune; oPLo Manual mode. The first pressure puts the instrument in manual mode (OPLO) while a second one puts the instrument in Auto mode; AAc Alarm reset; ASi Alarm acknowledge; chSP Sequential set point selection; St.by Stand by mode. The first press puts the instrument in stand by mode while a second one puts the instrument in Auto mode.; P.run Program run; P.rES Program reset; P.r.H.r Program run/hold/reset.	tunE

no.	Param.	Description	Dec. Point	Values	Default
89	diSP	Display management		nonE Standard display; Pou Output Power; PoS Valve position (servomotor control); SpF Final set point; Spo Operative set point; AL1 Alarm 1 threshold; AL2 Alarm 2 threshold; AL3 Alarm 3 threshold; Pr.tu - During a soak, the instrument shows the soak elapsed time;; - During a ramp the display shows the operative set point. At the end of the program execution, the instrument will show "P.End" messages alternately with the measured value; - When no program is running, the instrument shows the standard display; Pr.td - During a soak, the instrument shows the soak remaining time (count down); - During a ramp the display shows the operative set point. At the end of the program execution, the instrument shows "P.End" messages alternately with the measured value; - When no program is running, the instrument shows the standard display; P.t.tu When the programmer is running, the display shows the total elapsed time. At the end of the program execution, the instrument shows "P.End" messages alternately with the measured value; P.t.td When the programmer is running, the display shows the total remaining time (count down). At the end of the program execution, the instrument shows "P.End" messages alternately with the measured value; PErc Percent of the power output used during soft start (when the soft start time is equal to infinite, the limit is ever active and it can be used also when ON/OFF control is selected).	0
90	di.cL	Display colour		0The display colour is used to show the actual deviation (PV - SP); 1Display red (fix); 2Display green (fix); 3Display orange (fix).	0
91	AdE	Deviation for display colour management		1... 9999 (E.U.)	5
92	di.St	Display Timeout	2	- oFF (display always ON) - 0.1... 99.59 (mm.ss)	oFF
93	fiLd	Filter on the displayed value	1	- oFF (filter disabled) - From 0.0 (oFF) to 20.0 (E.U.)	oFF
94	bG.F	Bar graph Function	0	nonE Bargraph not lit Pou PID Output power (single action: 0... 100%, double action: -100... +100%) Po.h Energy Used (kWh) Pr.tu Elapsed time of the program in execution Pr.td Time to end of the program in execution Pr.tS Time to end of the program segment in execution	
95	dSPu	Instrument status at power ON		AS.Pr Starts in the same way it was prior to the power down; Auto Starts in Auto mode; oP.0 Starts in manual mode with a power output equal to zero; St.bY Starts in stand-by mode.	AS.Pr
96	oPr.E	Operative modes enabling		ALL All modes will be selectable by the next parameter; Au.oP Auto and manual (oP.L.o) mode only will be selectable by the next parameter; Au.Sb Auto and Stand-by modes only will be selectable by the next parameter.	ALL
97	oPEr	Operative mode selection		If oPr.E = ALL: - Auto = Auto mode; - oPLo = Manual mode; - St.bY = Stand by mode. If oPr.E = Au.oP: - Auto = Auto mode; - oPLo = Manual mode. If oPr.E = Au.Sb: - Auto = Auto mode; - St.bY = Stand by mode.	Auto

3 Ser group - Serial link parameters

no.	Param.	Description	Dec. Point	Values	Default	
98	Add	Instrument address		- oFF; - 1... 254.	1	
99	bAud	baud rate		1200 1200 baud; 2400 2400 baud; 9600 9600 baud; 19.2 19200 baud; 38.4 38400 baud.	9600	
100	trSP	Selection of the value to be retransmitted (Master)		nonE rSP PErc	Retransmission not used (the instrument is a slave); The instrument becomes a Master and retransmits the operative set point; The instrument become a Master and it retransmits the power output.	nonE

3 CAI group - User calibration parameters

no.	Param.	Description	Dec. Point	Values	Default
101	AL.P	Adjust Low Point		From -1999 to (AH.P - 10) in engineering units	0
102	AL.o	Adjust Low Offset		-300... +300 (E.U.)	0
103	AH.P	Adjust High Point		From (AL.P + 10) to 9999 (E.U.)	9999
104	AH.o	Adjust High Offset		-300... +300	0

3 PRG group - Programmer function parameters

no.	Param.	Description	Dec. Point	Values	Default
126	PAGE	Active program page election		1... 2	
127	Pr.n	Active program		1... 4	
128	Pr.St	Active program Status		rES run HoLd cnt	Program reset; Program Start; Program Hold; Continue (read only).

3 Pr1 Group - Program 1

no.	Param.	Description	Dec. Point	Values	Default	
129	P1.F	Program 1 - Action at power up	0	nonE S.uP.d S.uP.S u.diG u.dG.d	Programmer not used; Start at power up with a first step in stand-by; Start at power up; Start at Run command detection only; Start at Run command with a first step in stand-by.	nonE
130	P1.u	Program 1 - Engineering unit of the soaks	2	hh.nn nn.SS	Hours and minutes; Minutes and seconds.	hh.nn
131	P1.E	Program 1 - Instrument behaviour at the end of the program execution	0	cnt = SPAt St.by	Continue; Go to the set point selected by A.SP; Go to stand-by mode.	A.SP
132	P1.nE	Program 1 - Number of executions	0	1... 99 times/inF indefinitely		
133	P1.Et	Program 1 - Time of the end program indication	2	0.00 (oFF)/0.01... 99.59 nn.ss/inF (steady ON)		oFF
134	P1.S1	Program 1 - Set point of the first soak	dP	From SPLL to SPHL		0
135	P1.G1	Program 1 - Gradient of the first ramp	1	0.1... 999.9 (E.U./minute)/inF= Step transfer		inF
136	P1.t1	Program 1 - Time of the 1 st soak	2	0.00... 99.59 time units		0.10
137	P1.b1	Program 1 - Wait band of the 1 st soak	dP	From 0 (oFF) to 9999 (E.U.)		oFF
138	P1.E1	Program 1 - Events of the 1 st group	2	00.00... 11.11 (0 = event OFF; 1 = event ON)		00.00
139	P1.S2	Program 1 - Set point of the 2 nd soak	dP	OFF or from SPLL to SPHL		0
140	P1.G2	Program 1 - Gradient of the 2 nd ramp	1	0.1... 999.9 (E.U./minute)/inF= Step transfer		inF
141	P1.t2	Program 1 - Time of the 2 nd soak	2	0.00... 99.59 time units		0.10
142	P1.b2	Program 1 - Wait band of the 2 nd soak	dP	From 0 (oFF) to 9999 (E.U.)		oFF
143	P1.E2	Program 1 - Events of the 2 nd group	2	00.00... 11.11 (0 = event OFF; 1 = event ON)		00.00
144	P1.S3	Program 1 - Set point of the 3 rd soak	dP	OFF or from SPLL to SPHL		0
145	P1.G3	Program 1 - Gradient of the 3 rd ramp	1	0.1... 999.9 (E.U./minute)/inF= Step transfer		inF
146	P1.t3	Program 1 - Time of the 3 rd soak	2	0.00... 99.59 time units		0.10

no.	Param.	Description	Dec. Point	Values	Default
147	P1.b3	Program 1 - Wait band of the 3 rd soak	dP	From 0 (oFF) to 9999 (E.U.)	oFF
148	P1.E3	Program 1 - Events of the 3 rd group	0	00.00... 11.11 (0 = event OFF; 1 = event ON)	00.00
149	P1.S4	Program 1 - Set point of the 4 th soak	dP	OFF or from SPLL to SPHL	0
150	P1.G4	Program 1 - Gradient of the 4 th ramp	1	0.1... 999.9 (E.U./minute)/inF= Step transfer	inF
151	P1.t4	Program 1 - Time of the 4 th soak	2	0.00... 99.59 time units	0.10
152	P1.b4	Program 1 - Wait band of the 4 th soak	dP	From 0 (oFF) to 9999 (E.U.)	oFF
153	P1.E4	Program 1 - Events of the 4 th group	0	00.00... 11.11 (0 = event OFF; 1 = event ON)	00.00
154	P1.S5	Program 1 - Set point of the 5 th soak	dP	OFF or from SPLL to SPHL	0
155	P1.G5	Program 1 - Gradient of the 5 th ramp	1	0.1... 999.9 (E.U./minute)/inF= Step transfer	inF
156	P1.t5	Program 1 - Time of the 5 th soak	2	0.00... 99.59 time units	0.10
157	P1.b5	Program 1 - Wait band of the 5 th soak	dP	From 0 (oFF) to 9999 (E.U.)	oFF
158	P1.E5	Program 1 - Events of the 5 th group	0	00.00... 11.11 (0 = event OFF; 1 = event ON)	00.00
159	P1.S6	Program 1 - Set point of the 6 th soak	dP	OFF or from SPLL to SPHL	0
160	P1.G6	Program 1 - Gradient of the 6 th ramp	1	0.1... 999.9 (E.U./minute)/inF= Step transfer	inF
161	P1.t6	Program 1 - Time of the 6 th soak	2	0.00... 99.59 time units	0.10
162	P1.b6	Program 1 - Wait band of the 6 th soak	dP	From 0 (oFF) to 9999 (E.U.)	oFF
163	P1.E6	Program 1 - Events of the 6 th group	0	00.00... 11.11 (0 = event OFF; 1 = event ON)	00.00
164	P1.c2	Program 1 - Continues on program 2	0	no Program 1 is ended; YES program 1 will continue on program 2.	

² Pr2 Group - Program 2

no.	Param.	Description	Dec. Point	Values	Default
165	P2.F	Program 2 - Action at power up	0	nonE Programmer not used; S.uP.d Start at power up with a first step in stand-by; S.uP.S Start at power up; u.diG Start at Run command detection only; u.dG.d Start at Run command with a first step in stand-by.	nonE
166	P2.u	Program 2 - Engineering unit of the soaks	2	hh.nn Hours and minutes; nn.SS Minutes and seconds.	hh.nn
167	P2.E	Program 2 - Instrument behaviour at the end of the program execution	0	cnt = Continue; SPAt Go to the set point selected by A.SP; St.by Go to stand-by mode.	A.SP
168	P2.nE	Program 2 - Number of executions	0	1... 99 times/inF indefinitely	
169	P2.Et	Program 2 - Time of the end program indication	2	0.00 (oFF)/0.01... 99.59 nn.ss/inF (steady ON)	oFF
170	P2.S1	Program 2 - Set point of the first soak	dP	From SPLL to SPHL	0
171	P2.G1	Program 2 - Gradient of the first ramp	1	0.1... 999.9 (E.U./minute)/inF= Step transfer	inF
172	P2.t1	Program 2 - Time of the 1 st soak	2	0.00... 99.59 time units	0.10
173	P2.b1	Program 2 - Wait band of the 1 st soak	dP	From 0 (oFF) to 9999 (E.U.)	oFF
174	P2.E1	Program 2 - Events of the 1 st group	2	00.00... 11.11 (0 = event OFF; 1 = event ON)	00.00
175	P2.S2	Program 2 - Set point of the 2 nd soak	dP	OFF or from SPLL to SPHL	0
176	P2.G2	Program 2 - Gradient of the 2 nd ramp	1	0.1... 999.9 (E.U./minute)/inF= Step transfer	inF
177	P2.t2	Program 2 - Time of the 2 nd soak	2	0.00... 99.59 time units	0.10
178	P2.b2	Program 2 - Wait band of the 2 nd soak	dP	From 0 (oFF) to 9999 (E.U.)	oFF
179	P2.E2	Program 2 - Events of the 2 nd group	2	00.00... 11.11 (0 = event OFF; 1 = event ON)	00.00
180	P2.S3	Program 2 - Set point of the 3 rd soak	dP	OFF or from SPLL to SPHL	0
181	P2.G3	Program 2 - Gradient of the 3 rd ramp	1	0.1... 999.9 (E.U./minute)/inF= Step transfer	inF
182	P2.t3	Program 2 - Time of the 3 rd soak	2	0.00... 99.59 time units	0.10
183	P2.b3	Program 2 - Wait band of the 3 rd soak	dP	From 0 (oFF) to 9999 (E.U.)	oFF
184	P2.E3	Program 2 - Events of the 3 rd group	0	00.00... 11.11 (0 = event OFF; 1 = event ON)	00.00
185	P2.S4	Program 2 - Set point of the 4 th soak	dP	OFF or from SPLL to SPHL	0
186	P2.G4	Program 2 - Gradient of the 4 th ramp	1	0.1... 999.9 (E.U./minute)/inF= Step transfer	inF
187	P2.t4	Program 2 - Time of the 4 th soak	2	0.00... 99.59 time units	0.10
188	P2.b4	Program 2 - Wait band of the 4 th soak	dP	From 0 (oFF) to 9999 (E.U.)	oFF
189	P2.E4	Program 2 - Events of the 4 th group	0	00.00... 11.11 (0 = event OFF; 1 = event ON)	00.00
190	P2.S5	Program 2 - Set point of the 5 th soak	dP	OFF or from SPLL to SPHL	0
191	P2.G5	Program 2 - Gradient of the 5 th ramp	1	0.1... 999.9 (E.U./minute)/inF= Step transfer	inF
192	P2.t5	Program 2 - Time of the 5 th soak	2	0.00... 99.59 time units	0.10
193	P2.b5	Program 2 - Wait band of the 5 th soak	dP	From 0 (oFF) to 9999 (E.U.)	oFF

no.	Param.	Description	Dec. Point	Values	Default
194	P2.E5	Program 2 - Events of the 5 th group	0	00.00... 11.11 (0 = event OFF; 1 = event ON)	00.00
195	P2.S6	Program 2 - Set point of the 6 th soak	dP	OFF or from SPLL to SPHL	0
196	P2.G6	Program 2 - Gradient of the 6 th ramp	1	0.1... 999.9 (E.U./minute)/inF= Step transfer	inF
197	P2.t6	Program 2 - Time of the 6 th soak	2	0.00... 99.59 time units	0.10
198	P2.b6	Program 2 - Wait band of the 6 th soak	dP	From 0 (oFF) to 9999 (E.U.)	oFF
199	P2.E6	Program 2 - Events of the 6 th group	0	00.00... 11.11 (0 = event OFF; 1 = event ON)	00.00
200	P2.c3	Program 2 - Continues on program 3	0	no Program 2 is ended; YES Program 2 will continue on program 3.	

¹ Pr3 Group - Program 3

no.	Param.	Description	Dec. Point	Values	Default
201	P3.F	Program 3 - Action at power up	0	nonE Programmer not used; S.uPd Start at power up with a first step in stand-by; S.uPS Start at power up; u.diG Start at Run command detection only; u.dG.d Start at Run command with a first step in stand-by.	nonE
202	P3.u	Program 3 - Engineering unit of the soaks	2	hh.nn Hours and minutes; nn.ss Minutes and seconds.	hh.nn
203	P3.E	Program 3 - Instrument behaviour at the end of the program execution	0	cnt = Continue; SPAt Go to the set point selected by A.SP; St.by Go to stand-by mode.	A.SP
204	P3.nE	Program 3 - Number of executions	0	1... 99 times/inF indefinitely	
205	P3.Et	Program 3 - Time of the end program indication	2	0.00 (oFF)/0.01... 99.59 nn.ss/inF (steady ON)	oFF
206	P3.S1	Program 3 - Set point of the first soak	dP	From SPLL to SPHL	0
207	P3.G1	Program 3 - Gradient of the first ramp	1	0.1... 999.9 (E.U./minute)/inF= Step transfer	inF
208	P3.t1	Program 3 - Time of the 1 st soak	2	0.00... 99.59 time units	0.10
209	P3.b1	Program 3 - Wait band of the 1 st soak	dP	From 0 (oFF) to 9999 (E.U.)	oFF
210	P3.E1	Program 3 - Events of the 1 st group	2	00.00... 11.11 (0 = event OFF; 1 = event ON)	00.00
211	P3.S2	Program 3 - Set point of the 2 nd soak	dP	OFF or from SPLL to SPHL	0
212	P3.G2	Program 3 - Gradient of the 2 nd ramp	1	0.1... 999.9 (E.U./minute)/inF= Step transfer	inF
213	P3.t2	Program 3 - Time of the 2 nd soak	2	0.00... 99.59 time units	0.10
214	P3.b2	Program 3 - Wait band of the 2 nd soak	dP	From 0 (oFF) to 9999 (E.U.)	oFF
215	P3.E2	Program 3 - Events of the 2 nd group	2	00.00... 11.11 (0 = event OFF; 1 = event ON)	00.00
216	P3.S3	Program 3 - Set point of the 3 rd soak	dP	OFF or from SPLL to SPHL	0
217	P3.G3	Program 3 - Gradient of the 3 rd ramp	1	0.1... 999.9 (E.U./minute)/inF= Step transfer	inF
218	P3.t3	Program 3 - Time of the 3 rd soak	2	0.00... 99.59 time units	0.10
219	P3.b3	Program 3 - Wait band of the 3 rd soak	dP	From 0 (oFF) to 9999 (E.U.)	oFF
220	P3.E3	Program 3 - Events of the 3 rd group	0	00.00... 11.11 (0 = event OFF; 1 = event ON)	00.00
221	P3.S4	Program 3 - Set point of the 4 th soak	dP	OFF or from SPLL to SPHL	0
222	P3.G4	Program 3 - Gradient of the 4 th ramp	1	0.1... 999.9 (E.U./minute)/inF= Step transfer	inF
223	P3.t4	Program 3 - Time of the 4 th soak	2	0.00... 99.59 time units	0.10
224	P3.b4	Program 3 - Wait band of the 4 th soak	dP	From 0 (oFF) to 9999 (E.U.)	oFF
225	P3.E4	Program 3 - Events of the 4 th group	0	00.00... 11.11 (0 = event OFF; 1 = event ON)	00.00
226	P3.S5	Program 3 - Set point of the 5 th soak	dP	OFF or from SPLL to SPHL	0
227	P3.G5	Program 3 - Gradient of the 5 th ramp	1	0.1... 999.9 (E.U./minute)/inF= Step transfer	inF
228	P3.t5	Program 3 - Time of the 5 th soak	2	0.00... 99.59 time units	0.10
229	P3.b5	Program 3 - Wait band of the 5 th soak	dP	From 0 (oFF) to 9999 (E.U.)	oFF
230	P3.E5	Program 3 - Events of the 5 th group	0	00.00... 11.11 (0 = event OFF; 1 = event ON)	00.00
231	P3.S5	Program 3 - Set point of the 6 th soak	dP	OFF or from SPLL to SPHL	0
232	P3.G5	Program 3 - Gradient of the 6 th ramp	1	0.1... 999.9 (E.U./minute)/inF= Step transfer	inF
233	P3.t5	Program 3 - Time of the 6 th soak	2	0.00... 99.59 time units	0.10
234	P3.b5	Program 3 - Wait band of the 6 th soak	dP	From 0 (oFF) to 9999 (E.U.)	oFF
235	P3.E5	Program 3 - Events of the 6 th group	0	00.00... 11.11 (0 = event OFF; 1 = event ON)	00.00
236	P3.c4	Program 3 - Continues on program 4	0	no Program 3 is ended; YES Program 3 will continue on program 4.	

Pr4 Group - Program 4

no.	Param.	Description	Dec. Point	Values	Default
237	P4.F	Program 4 - Action at power up	0	nonE Programmer not used; S.u.P.d Start at power up with a first step in stand-by; S.u.P.S Start at power up; u.diG Start at Run command detection only; u.dG.d Start at Run command with a first step in stand-by.	nonE
238	P4.u	Program 4 - Engineering unit of the soaks	2	hh.nn Hours and minutes; nn.SS Minutes and seconds.	hh.nn
239	P4.E	Program 4 - Instrument behaviour at the end of the program execution	0	cnt = Continue; SPAt Go to the set point selected by A.SP; St.by Go to stand-by mode.	A.SP
240	P4.nE	Program 4 - Number of executions	0	1... 99 times/inF indefinitely	
241	P4.Et	Program 4 - Time of the end program indication	2	0.00 (oFF)/0.01... 99.59 nn.ss/inF (steady ON)	oFF
242	P4.S1	Program 4 - Set point of the first soak	dP	From SPLL to SPHL	0
243	P4.G1	Program 4 - Gradient of the first ramp	1	0.1... 999.9 (E.U./minute)/inF= Step transfer	inF
244	P4.t1	Program 4 - Time of the 1 st soak	2	0.00... 99.59 time units	0.10
245	P4.b1	Program 4 - Wait band of the 1 st soak	dP	From 0 (oFF) to 9999 (E.U.)	oFF
246	P4.E1	Program 4 - Events of the 1 st group	2	00.00... 11.11 (0 = event OFF; 1 = event ON)	00.00
247	P4.S2	Program 4 - Set point of the 2 nd soak	dP	OFF or from SPLL to SPHL	0
248	P4.G2	Program 4 - Gradient of the 2 nd ramp	1	0.1... 999.9 (E.U./minute)/inF= Step transfer	inF
249	P4.t2	Program 4 - Time of the 2 nd soak	2	0.00... 99.59 time units	0.10
250	P4.b2	Program 4 - Wait band of the 2 nd soak	dP	From 0 (oFF) to 9999 (E.U.)	oFF
251	P4.E2	Program 4 - Events of the 2 nd group	2	00.00... 11.11 (0 = event OFF; 1 = event ON)	00.00
252	P4.S3	Program 4 - Set point of the 3 rd soak	dP	OFF or from SPLL to SPHL	0
253	P4.G3	Program 4 - Gradient of the 3 rd ramp	1	0.1... 999.9 (E.U./minute)/inF= Step transfer	inF
254	P4.t3	Program 4 - Time of the 3 rd soak	2	0.00... 99.59 time units	0.10
255	P4.b3	Program 4 - Wait band of the 3 rd soak	dP	From 0 (oFF) to 9999 (E.U.)	oFF
256	P4.E3	Program 4 - Events of the 3 rd group	0	00.00... 11.11 (0 = event OFF; 1 = event ON)	00.00
257	P4.S4	Program 4 - Set point of the 4 th soak	dP	OFF or from SPLL to SPHL	0
258	P4.G4	Program 4 - Gradient of the 4 th ramp	1	0.1... 999.9 (E.U./minute)/inF= Step transfer	inF
259	P4.t4	Program 4 - Time of the 4 th soak	2	0.00... 99.59 time units	0.10
260	P4.b4	Program 4 - Wait band of the 4 th soak	dP	From 0 (oFF) to 9999 (E.U.)	oFF
261	P4.E4	Program 4 - Events of the 4 th group	0	00.00... 11.11 (0 = event OFF; 1 = event ON)	00.00
262	P4.S5	Program 4 - Set point of the 5 th soak	dP	OFF or from SPLL to SPHL	0
263	P4.G4	Program 4 - Gradient of the 5 th ramp	1	0.1... 999.9 (E.U./minute)/inF= Step transfer	inF
264	P4.t5	Program 4 - Time of the 5 th soak	2	0.00... 99.59 time units	0.10
265	P4.b5	Program 4 - Wait band of the 5 th soak	dP	From 0 (oFF) to 9999 (E.U.)	oFF
266	P4.E5	Program 4 - Events of the 5 th group	0	00.00... 11.11 (0 = event OFF; 1 = event ON)	00.00
267	P4.S6	Program 4 - Set point of the 6 th soak	dP	OFF or from SPLL to SPHL	0
268	P4.G6	Program 4 - Gradient of the 6 th ramp	1	0.1... 999.9 (E.U./minute)/inF= Step transfer	inF
269	P4.t6	Program 4 - Time of the 6 th soak	2	0.00... 99.59 time units	0.10
270	P4.b6	Program 4 - Wait band of the 6 th soak	dP	From 0 (oFF) to 9999 (E.U.)	oFF
271	P4.E6	Program 4 - Events of the 6 th group	0	00.00... 11.11 (0 = event OFF; 1 = event ON)	00.00

Pr5 Group - Program 5

no.	Param.	Description	Dec. Point	Values	Default
272	P5.F	Program 5 - Action at power up	0	nonE Programmer not used; S.u.P.d Start at power up with a first step in stand-by; S.u.P.S Start at power up; u.diG Start at Run command detection only; u.dG.d Start at Run command with a first step in stand-by.	nonE
273	P5.u	Program 5 - Engineering unit of the soaks	2	hh.nn Hours and minutes; nn.SS Minutes and seconds.	hh.nn
274	P5.E	Program 5 - Instrument behaviour at the end of the program execution	0	cnt = Continue; SPAt Go to the set point selected by A.SP; St.by Go to stand-by mode.	A.SP
275	P5.nE	Program 5 - Number of executions	0	1... 99 times/inF indefinitely	
276	P5.Et	Program 5 - Time of the end program indication	2	0.00 (oFF)/0.01... 99.59 nn.ss/inF (steady ON)	oFF

no.	Param.	Description	Dec. Point	Values	Default
277	P5.S1	Program 5 - Set point of the first soak	dP	From SPLL to SPHL	0
278	P5.G1	Program 5 - Gradient of the first ramp	1	0.1... 999.9 (E.U./minute)/inF= Step transfer	inF
279	P5.t1	Program 5 - Time of the 1 st soak	2	0.00... 99.59 time units	0.10
280	P5.b1	Program 5 - Wait band of the 1 st soak	dP	From 0 (oFF) to 9999 (E.U.)	oFF
281	P5.E1	Program 5 - Events of the 1 st group	2	00.00... 11.11 (0 = event OFF; 1 = event ON)	00.00
282	P5.S2	Program 5 - Set point of the 2 nd soak	dP	OFF or from SPLL to SPHL	0
283	P5.G2	Program 5 - Gradient of the 2 nd ramp	1	0.1... 999.9 (E.U./minute)/inF= Step transfer	inF
284	P5.t2	Program 5 - Time of the 2 nd soak	2	0.00... 99.59 time units	0.10
285	P5.b2	Program 5 - Wait band of the 2 nd soak	dP	From 0 (oFF) to 9999 (E.U.)	oFF
286	P5.E2	Program 5 - Events of the 2 nd group	2	00.00... 11.11 (0 = event OFF; 1 = event ON)	00.00
287	P5.S3	Program 5 - Set point of the 3 rd soak	dP	OFF or from SPLL to SPHL	0
288	P5.G3	Program 5 - Gradient of the 3 rd ramp	1	0.1... 999.9 (E.U./minute)/inF= Step transfer	inF
289	P5.t3	Program 5 - Time of the 3 rd soak	2	0.00... 99.59 time units	0.10
290	P5.b3	Program 5 - Wait band of the 3 rd soak	dP	From 0 (oFF) to 9999 (E.U.)	oFF
291	P5.E3	Program 5 - Events of the 3 rd group	0	00.00... 11.11 (0 = event OFF; 1 = event ON)	00.00
292	P5.S4	Program 5 - Set point of the 4 th soak	dP	OFF or from SPLL to SPHL	0
293	P5.G4	Program 5 - Gradient of the 4 th ramp	1	0.1... 999.9 (E.U./minute)/inF= Step transfer	inF
294	P5.t4	Program 5 - Time of the 4 th soak	2	0.00... 99.59 time units	0.10
295	P5.b4	Program 5 - Wait band of the 4 th soak	dP	From 0 (oFF) to 9999 (E.U.)	oFF
296	P5.E4	Program 5 - Events of the 4 th group	0	00.00... 11.11 (0 = event OFF; 1 = event ON)	00.00
297	P5.S5	Program 5 - Set point of the 5 th soak	dP	OFF or from SPLL to SPHL	0
298	P5.G5	Program 5 - Gradient of the 5 th ramp	1	0.1... 999.9 (E.U./minute)/inF= Step transfer	inF
299	P5.t5	Program 5 - Time of the 5 th soak	2	0.00... 99.59 time units	0.10
300	P5.b5	Program 5 - Wait band of the 5 th soak	dP	From 0 (oFF) to 9999 (E.U.)	oFF
301	P5.E5	Program 5 - Events of the 5 th group	0	00.00... 11.11 (0 = event OFF; 1 = event ON)	00.00
302	P5.S6	Program 5 - Set point of the 6 th soak	dP	OFF or from SPLL to SPHL	0
303	P5.G6	Program 5 - Gradient of the 6 th ramp	1	0.1... 999.9 (E.U./minute)/inF= Step transfer	inF
304	P5.t6	Program 5 - Time of the 6 th soak	2	0.00... 99.59 time units	0.10
305	P5.b6	Program 5 - Wait band of the 6 th soak	dP	From 0 (oFF) to 9999 (E.U.)	oFF
306	P5.E6	Program 5 - Events of the 6 th group	0	00.00... 11.11 (0 = event OFF; 1 = event ON)	00.00
307	P5.c6	Program 5 - Continues on program 6	0	no Program 5 is ended; YES Program 5 will continue on program 6.	

³ Pr6 Group - Program 6

no.	Param.	Description	Dec. Point	Values	Default
308	P6.F	Program 6 - Action at power up	0	nonE Programmer not used; S.uP.d Start at power up with a first step in stand-by; S.uP.S Start at power up; u.diG Start at Run command detection only; u.dG.d Start at Run command with a first step in stand-by.	nonE
309	P6.u	Program 6 - Engineering unit of the soaks	2	hh.nn Hours and minutes; nn.ss Minutes and seconds.	hh.nn
310	P6.E	Program 6 - Instrument behaviour at the end of the program execution	0	cnt = Continue; SPAt Go to the set point selected by A.SP; St.by Go to stand-by mode.	A.SP
311	P6.nE	Program 6 - Number of executions	0	1... 99 times/inF indefinitely	
312	P6.Et	Program 6 - Time of the end program indication	2	0.00 (oFF)/0.01... 99.59 nn.ss/inF (steady ON)	oFF
313	P6.S1	Program 6 - Set point of the first soak	dP	From SPLL to SPHL	0
314	P6.G1	Program 6 - Gradient of the first ramp	1	0.1... 999.9 (E.U./minute)/inF= Step transfer	inF
315	P6.t1	Program 6 - Time of the 1 st soak	2	0.00... 99.59 time units	0.10
316	P6.b1	Program 6 - Wait band of the 1 st soak	dP	From 0 (oFF) to 9999 (E.U.)	oFF
317	P6.E1	Program 6 - Events of the 1 st group	2	00.00... 11.11 (0 = event OFF; 1 = event ON)	00.00
318	P6.S2	Program 6 - Set point of the 2 nd soak	dP	OFF or from SPLL to SPHL	0
319	P6.G2	Program 6 - Gradient of the 2 nd ramp	1	0.1... 999.9 (E.U./minute)/inF= Step transfer	inF
320	P6.t2	Program 6 - Time of the 2 nd soak	2	0.00... 99.59 time units	0.10
321	P6.b2	Program 6 - Wait band of the 2 nd soak	dP	From 0 (oFF) to 9999 (E.U.)	oFF
322	P6.E2	Program 6 - Events of the 2 nd group	2	00.00... 11.11 (0 = event OFF; 1 = event ON)	00.00
323	P6.S	Program 6 - Set point of the 3 rd soak	dP	OFF or from SPLL to SPHL	0

no.	Param.	Description	Dec. Point	Values	Default
324	P6.G3	Program 6 - Gradient of the 3 rd ramp	1	0.1... 999.9 (E.U./minute)/inF= Step transfer	inF
325	P6.t3	Program 6 - Time of the 3 rd soak	2	0.00... 99.59 time units	0.10
326	P6.b3	Program 6 - Wait band of the 3 rd soak	dP	From 0 (oFF) to 9999 (E.U.)	oFF
327	P6.E3	Program 6 - Events of the 3 rd group	0	00.00... 11.11 (0 = event OFF; 1 = event ON)	00.00
328	P6.S4	Program 6 - Set point of the 4 th soak	dP	OFF or from SPLL to SPHL	0
329	P6.G4	Program 6 - Gradient of the 4 th ramp	1	0.1... 999.9 (E.U./minute)/inF= Step transfer	inF
330	P6.t4	Program 6 - Time of the 4 th soak	2	0.00... 99.59 time units	0.10
331	P6.b4	Program 6 - Wait band of the 4 th soak	dP	From 0 (oFF) to 9999 (E.U.)	oFF
332	P6.E4	Program 6 - Events of the 4 th group	0	00.00... 11.11 (0 = event OFF; 1 = event ON)	00.00
333	P6.S5	Program 6 - Set point of the 5 th soak	dP	OFF or from SPLL to SPHL	0
334	P6.G5	Program 6 - Gradient of the 5 th ramp	1	0.1... 999.9 (E.U./minute)/inF= Step transfer	inF
335	P6.t5	Program 6 - Time of the 5 th soak	2	0.00... 99.59 time units	0.10
336	P6.b5	Program 6 - Wait band of the 5 th soak	dP	From 0 (oFF) to 9999 (E.U.)	oFF
337	P6.E5	Program 6 - Events of the 5 th group	0	00.00... 11.11 (0 = event OFF; 1 = event ON)	00.00
338	P6.S6	Program 6 - Set point of the 6 th soak	dP	OFF or from SPLL to SPHL	0
339	P6.G6	Program 6 - Gradient of the 6 th ramp	1	0.1... 999.9 (E.U./minute)/inF= Step transfer	inF
340	P6.t6	Program 6 - Time of the 6 th soak	2	0.00... 99.59 time units	0.10
341	P6.b6	Program 6 - Wait band of the 6 th soak	dP	From 0 (oFF) to 9999 (E.U.)	oFF
342	P6.E6	Program 6 - Events of the 6 th group	0	00.00... 11.11 (0 = event OFF; 1 = event ON)	00.00
343	P6.c3	Program 6 - Continues on program 7	0	no Program 6 is ended; YES Program 6 will continue on program 7.	

³ Pr7 Group - Program 7

no.	Param.	Description	Dec. Point	Values	Default
344	P7.F	Program 7 - Action at power up	0	nonE Programmer not used; S.uP.d Start at power up with a first step in stand-by; S.uP.S Start at power up; u.diG Start at Run command detection only; u.dG.d Start at Run command with a first step in stand-by.	nonE
345	P7.u	Program 7 - Engineering unit of the soaks	2	hh.nn Hours and minutes; nn.SS Minutes and seconds.	hh.nn
346	P7.E	Program 7 - Instrument behaviour at the end of the program execution	0	cnt = Continue; SPAt Go to the set point selected by A.SP; St.by Go to stand-by mode.	A.SP
347	P7.nE	Program 7 - Number of executions	0	1... 99 times/inF indefinitely	
348	P7.Et	Program 7 - Time of the end program indication	2	0.00 (oFF)/0.01... 99.59 nn.ss/inF (steady ON)	oFF
349	P7.S1	Program 7 - Set point of the first soak	dP	From SPLL to SPHL	0
350	P7.G1	Program 7 - Gradient of the first ramp	1	0.1... 999.9 (E.U./minute)/inF= Step transfer	inF
351	P7.t1	Program 7 - Time of the 1 st soak	2	0.00... 99.59 time units	0.10
352	P7.b1	Program 7 - Wait band of the 1 st soak	dP	From 0 (oFF) to 9999 (E.U.)	oFF
353	P7.E1	Program 7 - Events of the 1 st group	2	00.00... 11.11 (0 = event OFF; 1 = event ON)	00.00
354	P7.S2	Program 7 - Set point of the 2 nd soak	dP	OFF or from SPLL to SPHL	0
355	P7.G2	Program 7 - Gradient of the 2 nd ramp	1	0.1... 999.9 (E.U./minute)/inF= Step transfer	inF
356	P7.t2	Program 7 - Time of the 2 nd soak	2	0.00... 99.59 time units	0.10
357	P7.b2	Program 7 - Wait band of the 2 nd soak	dP	From 0 (oFF) to 9999 (E.U.)	oFF
358	P7.E2	Program 7 - Events of the 2 nd group	2	00.00... 11.11 (0 = event OFF; 1 = event ON)	00.00
359	P7.S3	Program 7 - Set point of the 3 rd soak	dP	OFF or from SPLL to SPHL	0
360	P7.G3	Program 7 - Gradient of the 3 rd ramp	1	0.1... 999.9 (E.U./minute)/inF= Step transfer	inF
361	P7.t3	Program 7 - Time of the 3 rd soak	2	0.00... 99.59 time units	0.10
362	P7.b3	Program 7 - Wait band of the 3 rd soak	dP	From 0 (oFF) to 9999 (E.U.)	oFF
363	P7.E3	Program 7 - Events of the 3 rd group	0	00.00... 11.11 (0 = event OFF; 1 = event ON)	00.00
364	P7.S4	Program 7 - Set point of the 4 th soak	dP	OFF or from SPLL to SPHL	0
365	P7.G4	Program 7 - Gradient of the 4 th ramp	1	0.1... 999.9 (E.U./minute)/inF= Step transfer	inF
366	P7.t4	Program 7 - Time of the 4 th soak	2	0.00... 99.59 time units	0.10
367	P7.b4	Program 7 - Wait band of the 4 th soak	dP	From 0 (oFF) to 9999 (E.U.)	oFF
368	P7.E4	Program 7 - Events of the 4 th group	0	00.00... 11.11 (0 = event OFF; 1 = event ON)	00.00
369	P7.S5	Program 7 - Set point of the 5 th soak	dP	OFF or from SPLL to SPHL	0
370	P7.G5	Program 7 - Gradient of the 5 th ramp	1	0.1... 999.9 (E.U./minute)/inF= Step transfer	inF

no.	Param.	Description	Dec. Point	Values	Default
371	P7.t5	Program 7 - Time of the 5 th soak	2	0.00... 99.59 time units	0.10
372	P7.b5	Program 7 - Wait band of the 5 th soak	dP	From 0 (oFF) to 9999 (E.U.)	oFF
373	P7.E5	Program 7 - Events of the 5 th group	0	00.00... 11.11 (0 = event OFF; 1 = event ON)	00.00
374	P7.S6	Program 7 - Set point of the 6 th soak	dP	OFF or from SPLL to SPHL	0
345	P7.G6	Program 7 - Gradient of the 6 th ramp	1	0.1... 999.9 (E.U./minute)/inF= Step transfer	inF
376	P7.t6	Program 7 - Time of the 6 th soak	2	0.00... 99.59 time units	0.10
377	P7.b6	Program 7 - Wait band of the 6 th soak	dP	From 0 (oFF) to 9999 (E.U.)	oFF
378	P7.E6	Program 7 - Events of the 6 th group	0	00.00... 11.11 (0 = event OFF; 1 = event ON)	00.00
379	P7.c3	Program 7 - Continues on program 8	0	no Program 7 is ended; YES Program 7 will continue on program 8.	

³ Pr8 Group - Program 8

no.	Param.	Description	Dec. Point	Values	Default
380	P8.F	Program 8 - Action at power up	0	nonE Programmer not used; S.uP.d Start at power up with a first step in stand-by; S.uP.S Start at power up; u.diG Start at Run command detection only; u.dG.d Start at Run command with a first step in stand-by.	nonE
381	P8.u	Program 8 - Engineering unit of the soaks	2	hh.nn Hours and minutes; nn.ss Minutes and seconds.	hh.nn
382	P8.E	Program 8 - Instrument behaviour at the end of the program execution	0	cnt = Continue; SPAt Go to the set point selected by A.SP; St.by Go to stand-by mode.	A.SP
383	P8.nE	Program 8 - Number of executions	0	1... 99 times/inF indefinitely	
384	P8.Et	Program 8 - Time of the end program indication	2	0.00 (oFF)/0.01... 99.59 nn.ss/inF (steady ON)	oFF
385	P8.S1	Program 8 - Set point of the first soak	dP	From SPLL to SPHL	0
386	P8.G1	Program 8 - Gradient of the first ramp	1	0.1... 999.9 (E.U./minute)/inF= Step transfer	inF
387	P8.t1	Program 8 - Time of the 1 st soak	2	0.00... 99.59 time units	0.10
388	P8.b1	Program 8 - Wait band of the 1 st soak	dP	From 0 (oFF) to 9999 (E.U.)	oFF
389	P8.E1	Program 8 - Events of the 1 st group	2	00.00... 11.11 (0 = event OFF; 1 = event ON)	00.00
390	P8.S2	Program 8 - Set point of the 2 nd soak	dP	OFF or from SPLL to SPHL	0
391	P8.G2	Program 8 - Gradient of the 2 nd ramp	1	0.1... 999.9 (E.U./minute)/inF= Step transfer	inF
392	P8.t2	Program 8 - Time of the 2 nd soak	2	0.00... 99.59 time units	0.10
393	P8.b2	Program 8 - Wait band of the 2 nd soak	dP	From 0 (oFF) to 9999 (E.U.)	oFF
394	P8.E2	Program 8 - Events of the 2 nd group	2	00.00... 11.11 (0 = event OFF; 1 = event ON)	00.00
395	P8.S3	Program 8 - Set point of the 3 rd soak	dP	OFF or from SPLL to SPHL	0
396	P8.G3	Program 8 - Gradient of the 3 rd ramp	1	0.1... 999.9 (E.U./minute)/inF= Step transfer	inF
397	P8.t3	Program 8 - Time of the 3 rd soak	2	0.00... 99.59 time units	0.10
398	P8.b3	Program 8 - Wait band of the 3 rd soak	dP	From 0 (oFF) to 9999 (E.U.)	oFF
399	P8.E3	Program 8 - Events of the 3 rd group	0	00.00... 11.11 (0 = event OFF; 1 = event ON)	00.00
400	P8.S4	Program 8 - Set point of the 4 th soak	dP	OFF or from SPLL to SPHL	0
401	P8.G4	Program 8 - Gradient of the 4 th ramp	1	0.1... 999.9 (E.U./minute)/inF= Step transfer	inF
402	P8.t4	Program 8 - Time of the 4 th soak	2	0.00... 99.59 time units	0.10
403	P8.b4	Program 8 - Wait band of the 4 th soak	dP	From 0 (oFF) to 9999 (E.U.)	oFF
404	P8.E4	Program 8 - Events of the 4 th group	0	00.00... 11.11 (0 = event OFF; 1 = event ON)	00.00
405	P8.S5	Program 8 - Set point of the 5 th soak	dP	OFF or from SPLL to SPHL	0
406	P8.G5	Program 8 - Gradient of the 5 th ramp	1	0.1... 999.9 (E.U./minute)/inF= Step transfer	inF
407	P8.t5	Program 8 - Time of the 5 th soak	2	0.00... 99.59 time units	0.10
408	P8.b5	Program 8 - Wait band of the 5 th soak	dP	From 0 (oFF) to 9999 (E.U.)	oFF
409	P8.E5	Program 8 - Events of the 5 th group	0	00.00... 11.11 (0 = event OFF; 1 = event ON)	00.00
410	P8.S6	Program 8 - Set point of the 6 th soak	dP	OFF or from SPLL to SPHL	0
411	P8.G6	Program 8 - Gradient of the 6 th ramp	1	0.1... 999.9 (E.U./minute)/inF= Step transfer	inF
412	P8.t6	Program 8 - Time of the 6 th soak	2	0.00... 99.59 time units	0.10
413	P8.b6	Program 8 - Wait band of the 6 th soak	dP	From 0 (oFF) to 9999 (E.U.)	oFF
414	P8.E6	Program 8 - Events of the 6 th group	0	00.00... 11.11 (0 = event OFF; 1 = event ON)	00.00

